

22" Combination LED TV/DVD

Installation & Operating Instructions - Please keep for future reference

322/2579

BUSH

ELED22134FHDDVDCNTD



IMPORTANT - Please read these instructions fully before installing or operating

These instructions contain important information which will help you get the best from your television and ensure safe and correct installation and operation.

For any help concerning set up and use of your TV please call the Customer Helpline: 0 345 604 0105

Lines open: 9am - 8pm Monday to Saturday and 10am - 4pm Sunday

For any help concerning set up and use of your TV please call the Customer Helpline: 0 345 604 0105

Issue 1 - 9/2/11

Contents

Contents		
Contents	2	
 Safety Information	4	
Support	7	
Getting Started	8	
Features & Accessories	8	
Standby Notifications	9	
Viewing remote control	10	
Viewing remote control - DVD	11	
Attaching the Stand	12	
Control Buttons & Operation	13	
DVD - Control buttons	13	
Aerial & Cable connection	14	
Power connection	14	
Wall Mounting	14	
Remote control - Inserting batteries	14	
Switching the TV On and Off	14	
Switching the TV On	14	
Switching the TV Off	14	
First Time Installation	15	
Information Banner	16	
Connections	17	
General TV Operation	23	
Electronic programme guide (EPG)	23	
Basic Operations	24	
Displaying Subtitles	24	
Zoom Modes	24	
Using Main Menu Screen	24	
Configuring Date/Time Settings	24	
Source Settings	24	
Current Language	24	
Channel Management	25	
Moving a Channel	25	
Deleting a Channel	25	
Renaming a Channel	25	
Locking a Channel	25	
Button Functions	25	
Sorting Channel List	25	
Favourite Mode & Timers	26	
Favourite Mode	26	
Conditional Access	26	
Setting Sleep Timer	26	
Setting Programme Timers	26	
Editing a Timer	27	
Deleting a Timer	27	
Power Save Mode	27	
Repair Information	27	
Picture Controls	28	
Configuring Picture Settings	28	
Picture Settings Menu Items	28	
PC Picture Controls	29	
PC Picture Settings Operation	29	
Sound & Source Controls	31	
Other Controls	32	
Language Settings	33	
Language Settings	33	
Media Browser	34	
Starting Media Browser	34	
Media Browser Configuration	34	
Viewing Videos via USB	35	
Video Playback Screen	35	
Subtitle Time Correction	35	
Viewing Photos via USB	35	
Displaying Photos in Slideshow Mode	35	
Playing Music via USB	35	
Using MENU button in Media Browser Mode	36	
Insallation Controls	37	
Accessing Installation Menu	37	
Automatic Channel Scan (Retune)	37	
Manual Channel Scan	37	
Analogue Fine Tune	37	
First Time Installation	37	
Clear Service List	37	
Parental Control	38	
Teletext	39	
Connectivity Functions	40	
Connecting to a Wired Network	40	
Connecting to a Wireless Network	41	
Configuring Network Settings	42	
Configuring Wired Device Settings	42	
Network Type	42	
Configuration Status	42	
IP Address	42	

Contents

Configuring Wired Network Settings in Advanced Mode	42
Configuring Wireless Device Settings (Optional)	42
Information	43
Delete Saved Wifi Profiles	43
Connecting to your Cell Phone via WiFi (Optional)	43
Wireless Network Not Available	43
Connection is Slow	43
Distruption during playback or slow reactions	43
Using DLNA Network Service	44
Step 1: Nero Media Home Installation	44
Step 2: Connect to a Wired or Wireless Network	44
Step 3: Play Shared Files via Media Browser	44
Internet Portal)	45
iPlayer Application	45
DVD MODE	46
Handling Discs	46
Cleaning Discs	46
DVD - Features	46
How to watch a DVD	46
Notes on DVD Playback	46
DVD Mode Configuration	47
Internet Browser	50
Nero MediaHome Installation	51
Product Support	52
General Specifications	53
Plug replacement - UK and Ireland only	54
Supported File Formats for USB Media Browser	56
AV and HDMI Signal Compatibility & Typical PC Resolutions	57
Supported DVI Resolutions	58
DVD Mode Supported file formats	59
Compatible disc types	59
Software Upgrade	61
Manual Software Update	61

Disposal information 62

Guarantee 63

Model number

BUSH DVB-T-C ELED22134FHDDVDCNTD

Safety Information

 **IMPORTANT - Please read these instructions fully before installing or operating**

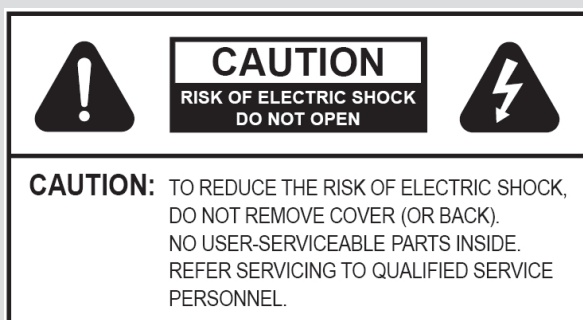

The lightning flash with arrowhead symbol, within an equilateral triangle, is intended to alert the user to the presence of uninsulated “dangerous voltage” within the product’s enclosure that may be of sufficient magnitude to constitute a risk of electric shock of persons.



The exclamation point within an equilateral triangle is intended to alert the user to the presence of important operating and maintenance (servicing) instructions in the literature accompanying the appliance.

Preparation

Place the device on a solid even surface. For ventilation, leave a free space of at least 10 cm all around the set. To prevent any fault and unsafe situations, do not place any objects on top of the set. Use this device in moderate climates.

Operation temperature and operation humidity: 0°C up to 40°C, 85% rel. humidity max. (not blocking ventilation openings).

Intended Use

This device is used to receive and display TV programmes. The different connection options make an additional expansion of the reception and display sources possible (various external devices). This device is only suitable for the operation in dry interiors. This appliance is intended solely for private domestic use and may not be used for industrial and commercial purposes. We exclude liability in principle, if the device is not used as intended, or unauthorized modifications have been made. To operate your LCD TV in extreme ambient conditions may cause the damage of the device.

 **WARNING:** Never let people (including children) with physical, sensory or mental abilities or lack of experience and / or knowledge unsupervised use electrical device!

Children may not recognize dangers right! The swallowing of batteries can be fatal. Keep batteries always out of reach of small children. If a battery is swallowed, immediately seek medical attention. Keep the packaging films out of reach of children. Risk of suffocation.

Power source

- The TV should be operated only from a 220-240 V AC, 50 Hz outlet.
-  **Warning:** Do not leave your TV in standby or operating mode when you leave your house.

Positioning the TV

- For ventilation, please leave a clear space of at least 10cm all around the TV.
- **Do not** block the ventilation openings.
- **Do not** place the TV on sloping or unstable surfaces, the TV may tip over.
- To prevent damage to the TV, **do not** place any objects on top of the TV.
- Only use the TV in moderate climates.

Power cord and plug

- The power cord plug should be easily accessible. In case of storms and lightning, when going on holiday, or when the TV is not used for a long period of time disconnect the power cord from the mains power socket.
- The mains plug is used to disconnect TV set from the mains and therefore it must remain readily operable.
- **Do not** place the TV, furniture, etc. on the power cord or pinch the cord.
- Handle the power cord by the plug, **do not** unplug the TV by pulling the power cord.

Safety Information

IMPORTANT - Please read these instructions fully before installing or operating

- Never touch the power cord/plug with wet hands as this could cause a short circuit or electric shock.
- Never make a knot in the power cord or tie it with other cords.
- Power cords should be placed in such a way that they are not likely to be stepped on or driven over.
- A damaged power cord/plug can cause fire or give you an electric shock. When damaged it must be replaced, this should only be done by qualified personnel.



Moisture and Water

- **Do not** use this TV in a humid or damp place (avoid bathrooms, the sink in the kitchen, and near the washing machine).
- **Do not** expose this TV to rain or water, as this may be dangerous.
- **Do not** place objects filled with liquids, such as flower vases, on top of the TV. Avoid from dripping or splashing.
- If any solid object or liquid falls into the cabinet, unplug the TV and have it checked by qualified personnel before operating it any further.

Ventilation

- The slots and openings on the TV set are intended for ventilation and to ensure reliable operation.
- To prevent overheating, these openings must not be blocked or covered in anyway.

Heat sources and Flames

- **Do not** expose the TV to direct sunlight or other heat sources.
- The TV should not be placed near to open flames and sources of intense heat such as an electric heater. 
- Ensure that no open flame sources, such as lighted candles, are placed on top of the TV. 

Headphone Volume

- Excessive sound pressure from earphones and headphones can cause hearing loss, please take care. 

Wall Mounting (optional)

- To prevent injury, this TV must be securely attached to the wall in accordance with the installation instructions (if the option is available).

LCD Screen

- Occasionally, a few non-active pixels may appear on the screen as a fixed blue, green or red point. Please note that this does not affect the performance of your product.
- Take care not to scratch the screen with fingernails or other hard objects.

Cleaning

- Before cleaning, unplug the TV from the wall socket.
- **Do not** use liquid or aerosol cleaners. Only use a soft, dry cloth.

Servicing

-  **Warning:** Risk of exposure to radiation from class 1/class 3b visible and invisible laser beams. **Do not** open the TV and stare directly into beam.



-  **Warning:** Risk of electric shock, **do not** attempt to repair, service or modify this TV yourself. Contact the manufacturer, their approved service agent

Safety Information

 **IMPORTANT** - Please read these instructions fully before installing or operating

Batteries

•  **Warning:** Incorrect installation of batteries may cause battery leakage and corrosion, resulting in damage to the remote control.



- **Do not** mix old and new batteries, or batteries of different types.
- **Do not** dispose of batteries in a fire.
- **Do not** dispose of batteries with normal household waste, take to a local recycling centre.

 **CAUTION:** Insert the batteries / rechargeable batteries in the correct polarity. Don't try to recharge non rechargeable batteries and under no circumstances throw them into fire. Danger of explosion. Do not use unequal batteries (old and new, Alkaline and carbon, etc.) simultaneously. If you will not use the device for a long time, remove the batteries and store the device in a dry and dust free place. Improper use of batteries may cause an explosion or leakage. If the batteries have leaked, use gloves and clean the appliance thoroughly with a dry cloth! Batteries should not be exposed to heat, such as sunshine, fire or the like.

Replacement Parts

When replacement parts are required, make sure that the service technician has used replacement parts, which are specified by the manufacturer or have the same specifications as the original one. Unauthorised substitutions may result in fire, electrical shock or other hazards.

Taking out of service and storing

Unplug the TV from the mains and pack the TV in an appropriate cardboard box. Remove the batteries from the remote control and pack the remote control to the TV set.



NOTE: The TV set should be stored in a dry and dust-free room.

Connection to a Television Distribution System (Cable TV etc.) from Tuner

Device connected to the protective earthing of the building installation through the mains connection or through other apparatus with a connection to protective earthing-and to a television distribution system using coaxial cable, may in some circumstances create a fire hazard.

Connection to a cable distribution system has therefore to be provided through a device providing electrical isolation below a certain frequency range (galvanic isolator, see EN 60728-11).

Symbols in this Instruction Book

The following symbols are used in the Instruction Book as a marker for restrictions and precautions and safety instructions. Note such information for security reasons.

WARNING

If you do not pay attention to such a marked warning, it can cause serious injury or death. Note these warnings strictly, in order to ensure a safe operation.

CAUTION

Such a precaution is marked, you should take up or note, to avoid injury or property damage. Note these instructions strictly, in order to ensure a safe operation.

IMPORTANT

Warnings on the appliance and restrictions are displayed like this. Read this information strictly in order to operate the system correctly and avoid damage.



NOTE: Information about the operation and additional explanations are marked like this. To be aware of such information is recommended to ensure that the functions can be used optimally.

The illustrations and the OSD in this operation manual are for explanation purposes and may vary slightly from the actual operations.

Technical experts are available 7 days a week

- **Simple help and advice on setting up your digital equipment (image).**
- **Guidance on connecting other devices to your television such as a DVD player, Sky, home cinema system or a games console.**
- **Order spare parts, including that lost remote control.**
- **Any other technical issues you may need assistance with.**

Call us today: 0 345 604 0105

Local call rates applies*

Lines open 9am-8pm Monday to Saturday and 10am-4pm Sunday.

*Calls to Argos enquiry lines may attract a charge and set up fee from residential lines depending on your call plan/tariff. Mobile and other providers costs may vary, see www.bt.com/pricing for details.

For Security and training purposes, telephone calls to and from customer service centres maybe recorded and monitored. Calls from Republic of Ireland will attract international call charges.

Getting Started

Features & Accessories

TV - Features

- Remote controlled colour LCD TV.
- Fully integrated digital TV (DVB-T).
- HDMI connectors for digital video and audio. This connection is also designed to accept high definition signals.
- USB input.
- 1000 programmes.
- OSD menu system.
- Scart socket for external devices (such as video, video games, audio set, etc.).
- Stereo sound system.
- Teletext, fasttext, TOP text.
- Headphone connection.
- Automatic programming system.
- Forward or backward manual tuning.
- Automatic power down after up to six hours.
- Sleep timer.
- Child lock.
- Automatic sound mute when no transmission.
- NTSC playback.
- AVL (Automatic Volume Limiting).
- PLL (Frequency Search).
- PC input.
- Plug&Play for Windows 98, ME, 2000, XP, Vista, Windows 7.
- Game Mode (optional).
- Picture off function.
- Ethernet (LAN) for Internet connectivity and service
- Picture Off function
- 802.11n built in WIFI Support
- DLNA

Accessories included

Remote Control
Batteries: 2 x AAA
Instruction Book
Quick Start Guide
Side AV Connection Cable
Wifi USB Dongle
USB Cable



NOTE: You should check the accessories after purchasing. Make sure that each accessory is included.

Getting Started

Standby Notifications

If the TV switches off while in No Signal mode, the following on-screen message will be displayed on the next switch-on:

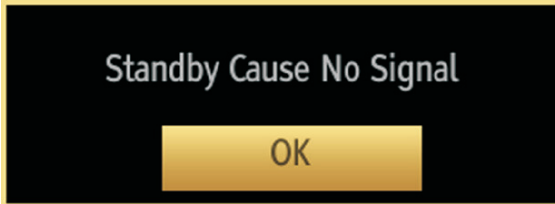

When the Auto Tv Off timeout is reached, the following message will be displayed on the screen. Select YES to shut down the TV. Select NO to cancel. The TV will switch off as well, if you do not make a selection on this screen.

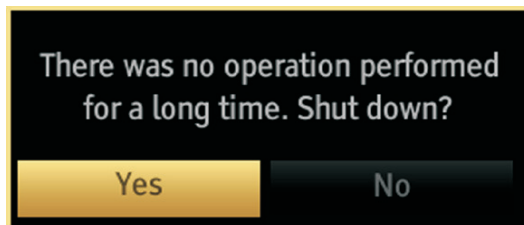

If the TV switches off owing to the auto power down feature, the following on-screen message will be displayed on the next switch-on:

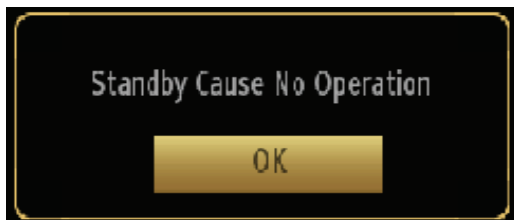

Getting Started

Viewing remote control

1. Source
2. Launches Netflix Application
3. Internet Portal
4. Play (in media browser mode)
5. No function
6. Rapid reverse (in media browser mode)
7. Mono/Stereo - Dual I-II / Current language (in DVB channels)
8. Green button
9. Red button
10. Numeric buttons
11. Channel List/TV source
12. Menu
13. Volume up / down
14. Back (Return) / Index (in TXT mode)
15. Favourite channel list
16. Expand (in TXT mode) / Screen size
17. My button 1 / Youtube (*)
18. My button 2 (**)
19. Teletext / Mix
20. Electronic programme guide
21. Mute
22. Info / Reveal (in TXT mode)
23. Exit
24. Ok / Select / Hold (in TXT mode)
25. Programme up / down
26. Navigation buttons
27. Quick menu
28. Previous programme
29. Blue button
30. Yellow button
31. Subtitle on / off
32. Rapid advance (in media browser mode)
33. Stop (in media browser mode)
34. Pause (in media browser mode)
35. Media browser
36. Launches Youtube
37. Standby button
38. Function LED

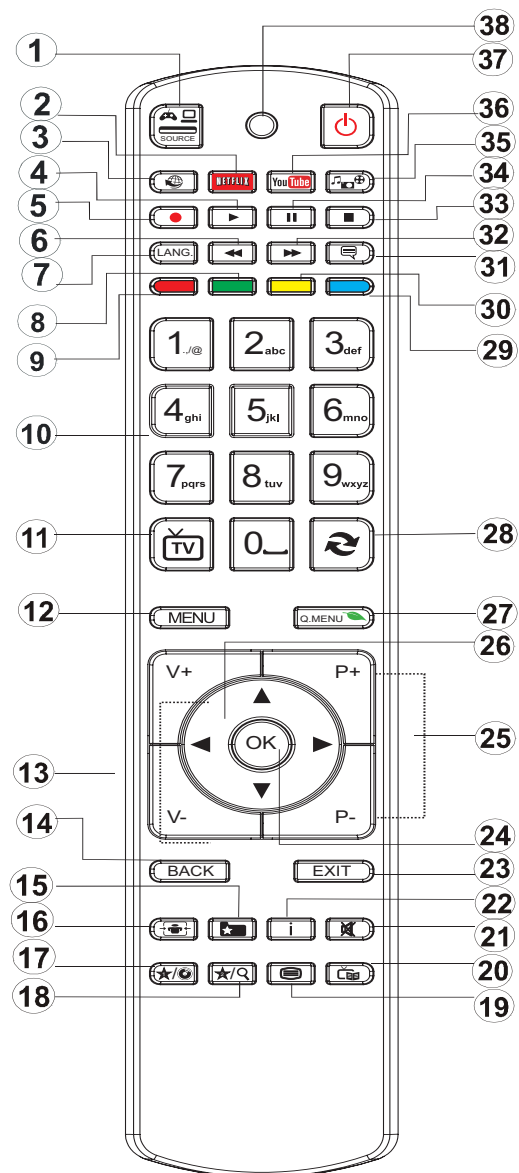

Using My button 1 (*)

This button's main function is to run Youtube link. However, if you want to change this function, you can press MY BUTTON 1 for five seconds when on a desired source, channel or link, until the "MY BUTTON IS SET" message is displayed on the screen. This confirms that the selected MY BUTTON is now associated with the selected function. Note that if you perform first time installation, MY BUTTON 1 will return to its default function

Using My Button 2 (**)

This button's main function is to switch between DVB-T and DVB-C broadcasts. However, if you press MY BUTTON 2 for five seconds, you can set a function to it as described in My Button 1.

Note that if you perform first time installation, MY BUTTON 2 will return to its default function.

Getting Started

Viewing remote control - DVD

1. Play
2. No function
3. Rapid reverse
4. Language selection
5. Repeat
6. Zoom
7. Numeric buttons
8. TV Menu
9. Back
10. Display / DVD Menu
11. Search mode
12. Info
13. OK / Select
14. Navigation buttons
15. Title
16. Root
17. Subtitle
18. Rapid advance
19. Stop
20. Pause
21. Angle
22. Standby

 **NOTE:** Remote Control buttons that are not indicated with a number cannot be used in DVD mode.

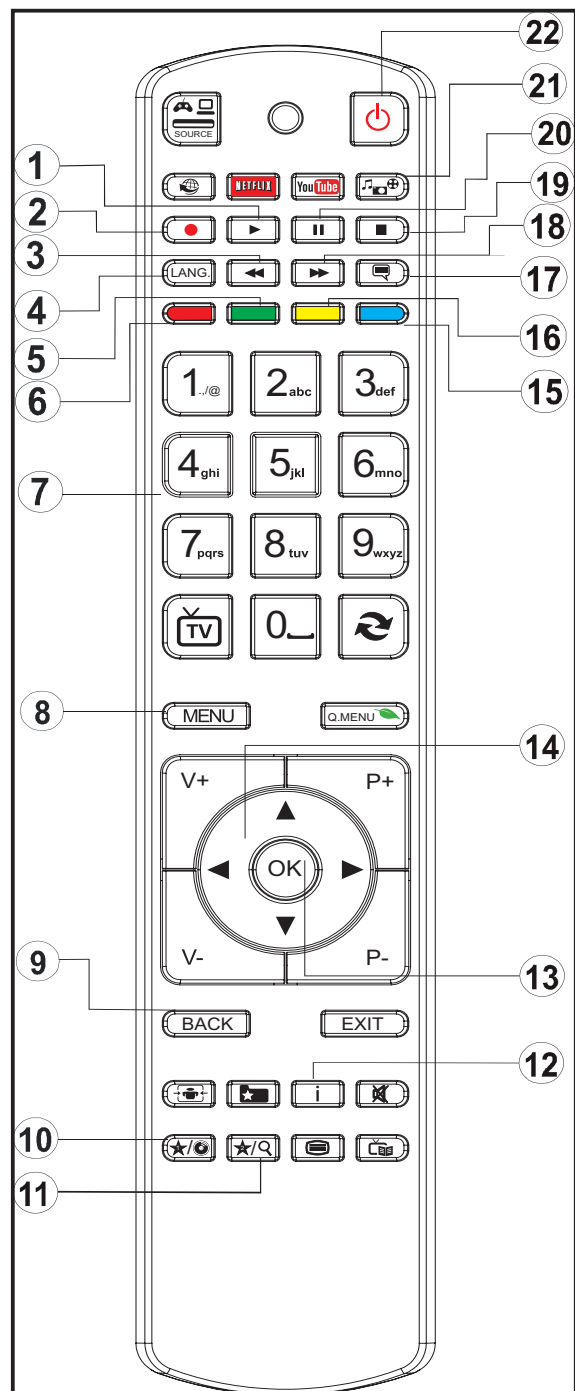

Getting Started

Attaching the Stand

1. Stand is placed on a flat surface (fig.1).

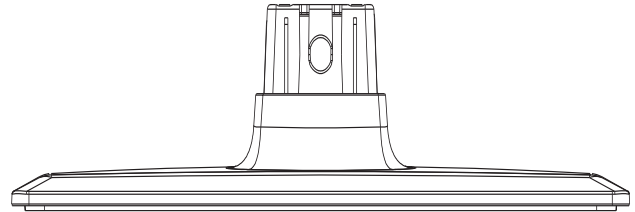

fig.1

2. The product is held over the stand so that it coincides with the stand mounting point and then it is left to be mounted with its own weight (fig.2).

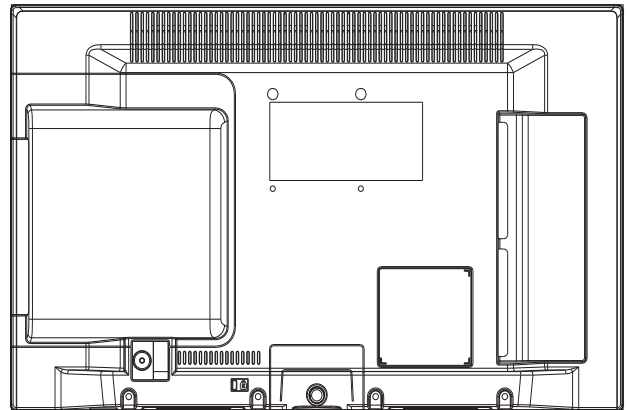

fig.2

Getting Started

Control Buttons & Operation

1. Up direction
2. Down direction
3. Programme/Volume / AV / Standby-On selection switch

The Control switch allows you to control the Volume/ Programme/ Source and Standby-On functions of the TV.

To change volume: Increase the volume by pushing the button up. Decrease the volume by pushing the button down.

To change channel: Press the middle of the button, the channel information banner will appear on screen. Scroll through the stored channels by pushing the button up or down

To change source: Press the middle of the button twice, the source list will appear on screen. Scroll through the available sources by pushing the button up or down.

To turn the TV off: Press the middle of the button down and hold it down for a few seconds, the TV will turn into standby mode.



NOTE: You can move the switch, upward or downward to change the volume. If you want to change the channel, press the middle of the switch once (Position 3) and then move upward or downward. If you press the middle of the switch once more, the source OSD will be displayed. To select desired source, move the switch upward or downward and release. If you press the middle of the switch and hold for a few seconds, the TV will switch to standby mode. The Main menu OSD cannot be displayed via the control buttons on the TV.

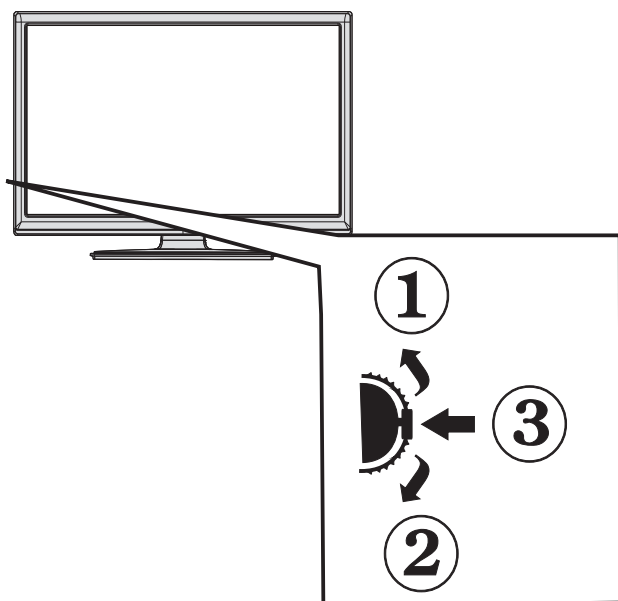

Operation with the Remote Control

Volume Setting

Press V + button to increase the volume. Press V - button to decrease the volume. A volume level scale (slider) will be displayed on the screen.

Programme Selection (Previous or Next Programme)

Press P - button to select the previous programme. Press P + button to select the next programme.

Programme Selection (Direct Access)

Press number buttons on the remote control to select programmes between 0 and 9. The TV will switch to the selected programme. To select programmes between 10-10000, press the number buttons consecutively.

DVD - Control buttons

1. Disc loader.
2. Play / Pause (▶ / ||) button
Plays / pauses the disc. When DVD menu (root menu) is active, this button functions as "button select" (selects the highlighted item in menu) if this is not prohibited by the disc).
3. Stop / Eject (■ / ▶) button.
Stops the disc playing / Ejects or Loads the disc.



NOTE: You cannot eject the disc via the remote control. To eject while playing a file; you should press the STOP button "■ / ▶" (on the TV) three times.

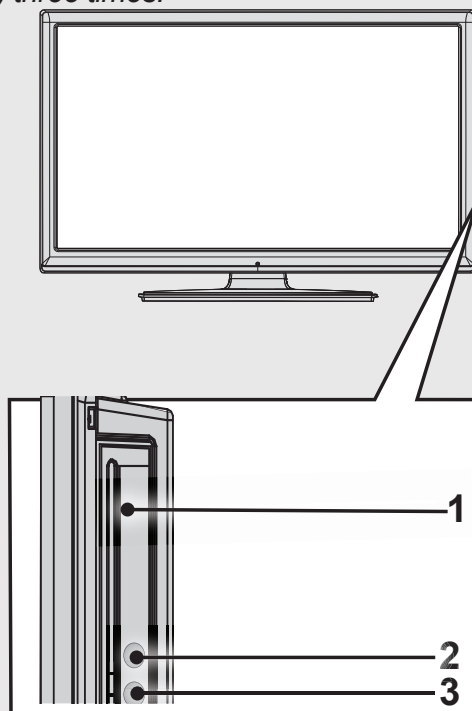

Getting Started

Aerial & Cable connection

Connect the “aerial” or “cable TV” plug to AERIAL INPUT (ANT.) socket located on the back of the TV (fig.1).

Power connection



IMPORTANT :The TV set is designed to operate on 220-240V AC, 50 Hz.

Please note: After unpacking, allow the TV to reach ambient room temperature before connecting the TV to the mains power socket.

Connect the power cord plug to the mains power socket.

The LED on the front of the TV then lights up, this indicates that the TV is in ‘Standby’ mode.

Wall Mounting

When wall mounting please ensure you use a compatible wall mount (not supplied). This TV conforms to the VESA mounting specifications and is 75 x 75 mm.

Remote control - Inserting batteries

Remove the battery cover on the back of the remote control, gently push down and pull backwards at the same time as shown.

Insert two **AAA/R3** or equivalent type batteries. Ensure the batteries are inserted the correct way and replace the battery cover (fig.2).



NOTE: When the remote control is not going to be used for long periods of time, the batteries should be removed. Otherwise the remote control may be damaged, caused by battery leakage and corrosion.

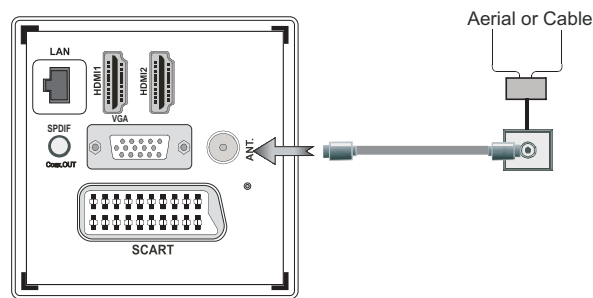

(fig.1)

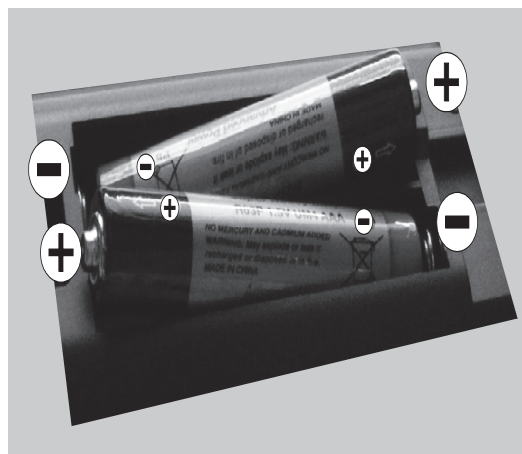

AAA/R3 x 2 Batteries

(fig.2)

Switching the TV On and Off



Switching the TV On

With power cord plug connected to the mains power socket, the TV is in ‘Standby’ mode.

To switch the TV on from standby mode:



Press the “” button and the TV will switch to standby mode. Then the standby LED lights up.

To switch on the TV from standby mode either:

- Press the “” button, P+ / P- or a numeric button on the remote control.
- Press the middle of the “” button on the TV..

By either method the TV will switch on.

Switching the TV Off

Press the “” button on the remote control or press the standby “” button, so the TV will switch to standby mode.

To turn off the TV completely, remove the power cord plug from the mains power socket.

 **NOTE:** When the TV is in standby mode, the standby LED can blink to indicate that features such as Standby Search, Over Air Download or Timer is active.

 **NOTE:** If you switch on your TV via P +/- buttons on the remote control or +/- on the TV set, the programme that you were watching last will be reselected.

Getting Started

First Time Installation

When turned on for the first time, the “language selection” menu appears. The message “**Welcome please select your language!**” is displayed in all language options listed alphabetically.

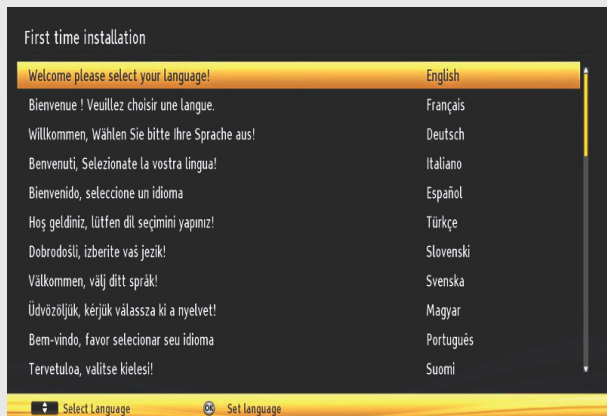

Press the “ \wedge ” or “ \vee ” button to highlight the required language, press **OK** button to select. “First Time Installation” appears. Use “ \leftarrow ” or “ \rightarrow ” button to set the required country, and press “ \vee ” button to select Search Type. Use “ \leftarrow ” or “ \rightarrow ” to set the desired search type. Available search types are Digital and analog, digital only and analog only. When set, press “ \vee ” to select Teletext Language. Use “ \leftarrow ” or “ \rightarrow ” button to set the “Teletext Language” and select “Scan Encrypted” using “ \wedge ” or “ \vee ” button. You can set **Scan Encrypted** as **Yes** if you want to scan coded stations.

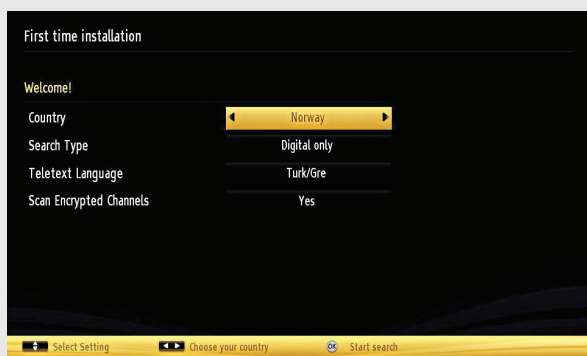

Press **OK** button on the remote control to continue and the following message will be displayed on the screen.

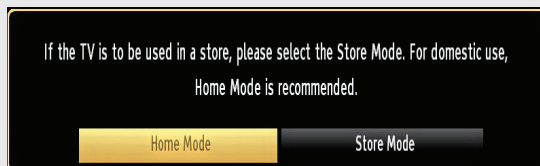

You can activate Store mode option by using “ \leftarrow ” or “ \rightarrow ” button. If Store Mode (optional) is selected, Store mode option will be available in other settings menu and your TV’s settings will be optimized for

best display quality. A confirmation screen will be displayed after selecting the Store Mode. Select **YES** to proceed.

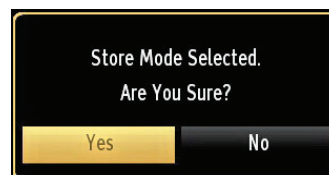

If Home Mode is selected, Store mode will not be available after the First Time Installation. Press **OK** button on the remote control to continue and the following message will be displayed on the screen.

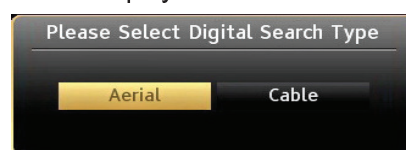

You must select a search type to search and store broadcasts from the desired source.

Aerial Installation

If you select **AERIAL** option from the **Search Types** screen, the television will search for digital terrestrial TV broadcasts.

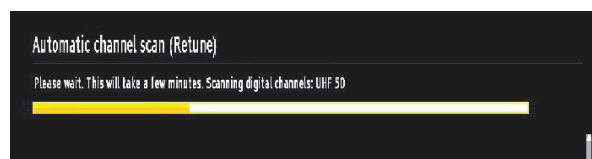

 **NOTE:** You can press “**MENU**” button to cancel.

After all the available stations are stored, Channel List will be displayed on the screen. If you like the sort channels, according to the LCN (if available*), please select “Yes” and than press **OK**.



Press **OK** button to quit channel list and watch TV.

(* *LCN is the Logical Channel Number system that organizes available broadcasts in accordance with a recognizable channel sequence.*

Getting Started

Cable Installation

If you select CABLE option and press **OK** button on the remote control to continue, the following message will be displayed on the screen:



To continue please select **YES** and press **OK**. To cancel operation, select **NO** and press **OK**.

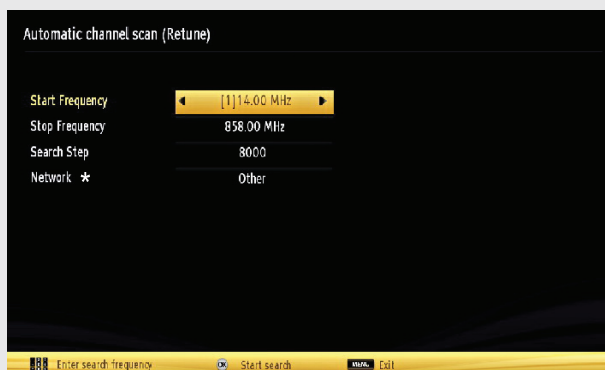

You can select frequency ranges from this screen. For highlighting lines you see, use “**^**” or “**v**” button.

You can enter the frequency range manually by using the numeric buttons on the remote control.

Set **Start** and **Stop Frequency** as desired by using numeric buttons on the remote control.

After this operation, you can set **Search Step** as 8000 KHz or 1000 KHz.

If you select 1000 KHz, the TV will perform search process in a detailed way. Searching duration will thus increase accordingly.

When finished, press **OK** button to start automatic search. The TV will search and store available broadcasts.

(*) *Network option will not be available for UK.*

Information Banner

Whenever you change channel using the **P-/P+** buttons or the numeric buttons, the TV displays the broadcast picture along with an information banner at the bottom of the screen.

The information banner can be displayed at any time while watching TV by pressing the **INFO** button on the remote control (fig.8).



Hint: *Not all channels broadcast the programme data. If the name and time of the programme are not available, then information banner will be displayed with blanks.*

If the selected channel is locked, you must enter the correct four-digit numeric code to view the channel (default code is **0000**, **except for the France**). “**Enter PIN**” will be displayed on the screen in such a case.

Connections

Back connections explained

1. Ethernet (LAN) Input

2. HDMI Input

Connects a device that has an HDMI socket. The TV can display High Definition pictures from devices such as a High Definition Satellite Receiver or DVD Player. These devices must be connected via the HDMI sockets or Component Socket. No sound connection is needed for an HDMI to HDMI connection.

3. S/PDIF Out

Outputs audio signals of the currently watched source. Use an SPDIF audio cable to transfer audio signals to a device that has S/PDIF input.

4. PC Input (VGA)

Connects a personal computer to the TV. Connect the PC cable between the PC INPUT on the TV and the PC output on the PC. You can use the PC input to allow YPbPr signal connection with a device that has component output. Connect the YPbPr to PC cable between the PC INPUT on the TV and the component video outputs of the device.

5. SCART socket

Inputs or outputs for external devices. Connect the SCART cable between the SCART socket on the TV and the SCART socket on the external device (decoder, VCR or DVD player).

 **NOTE:** If an external device is connected via the SCART sockets, the TV will automatically switch to AV mode. When receiving DTV channels (Mpeg4 H.264) or while in Media Browser mode, output will not be available via the scart sockets.

6. RF Input (ANT.)

Connects to aerial (antenna) or cable TV. If you use a decoder or a media recorder, you should connect the aerial cable through the device to the TV with an appropriate aerial cable.

 **NOTE:** When using the wall mounting kit (optional), we recommend that you plug all your cables into the back of the TV before mounting on the wall.

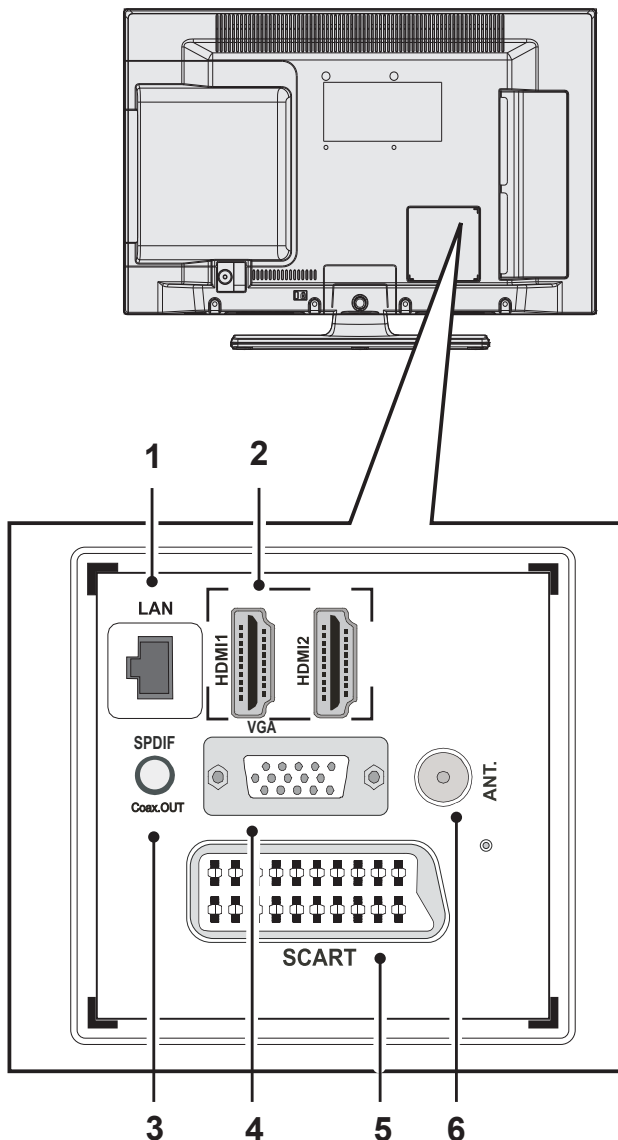

Connections

Left side connections explained

7. CI Slot

Used to insert a CI card. A CI card allows you to view all the channels that you subscribe to. For more information, see “Conditional Access” section.

8. USB Input

To connect USB disks to the TV, providing fast data exchange. Also used for connection the wifi USB dongle (supplied with your TV).

9. Side audio-video input

This input is used for connecting video and audio signals of external devices. To make a video connection, you must use the supplied AV connection cable for enabling connection. First, plug singular jack of the cable to the TV's Side AV socket. Afterwards, insert your video cable (not supplied) connector into the YELLOW input (located on the side with several connectors) of the supplied AV connection cable. Colours of the connected jacks should match. To enable audio connection, you must use RED and WHITE inputs of the side AV connection cable. Afterwards, insert your device's audio cable connectors into the RED and WHITE jack of the supplied side AV connection cable. Colours of the connected jacks should match.

10. Headphone

Headphone jack is used for connecting an external headphone to the system. Connect to the HEADPHONE jack to listen to the TV from headphones.

11. Magic Button

Volume/ Programme/ Source and Standby-On switch.

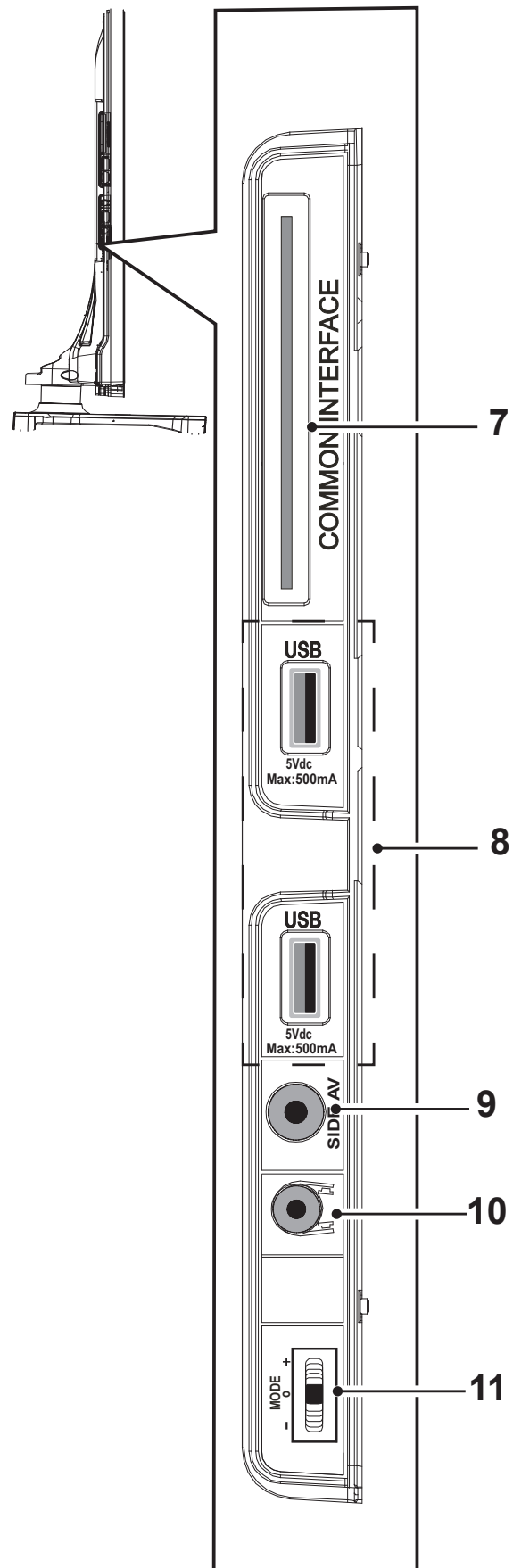

Connections

HDMI Connections

HDMI lets you enjoy high definition digital images and high quality sound by connecting the TV to external devices such as DVD players, set top boxes or gaming equipment (fig.1).

Power off both the TV and the device before making any connections. For more information, refer to your device's own instruction book. After making the connection, switch to HDMI 1, HDMI 2 as a source, depending on which HDMI connector the external equipment is connected. See, **Input Selection** section for more information on changing sources.

 **NOTE:** HDMI cable is not supplied.

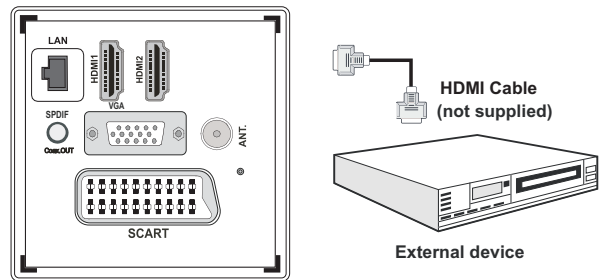

(fig.1)

SCART Connections

Most devices support SCART connection. You can connect a DVD recorder, VCR or decoder to the TV using the SCART socket (fig.2).

Power off both the TV and the device before making any connections. For more information, refer to your device's own instruction book. The Scart cable is not supplied.

 **NOTE:** If your external device has a **S-Video output**, it is possible to connect your external device with a **SCART-S-video adapter** (not included) to the scart input of the TV. First plug the SCART S-Video adapter to the SCART connector on your TV set. Then, connect a S-video cable to the SCART socket (via the Scart S-Video adapter) to the S-video output of your external device.

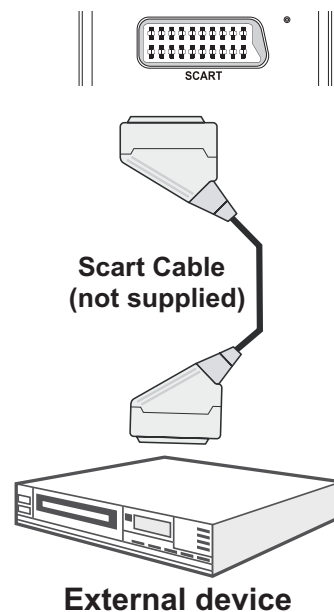

(fig. 2)

VGA Connections

You can connect a computer (PC) to the TV to display your computer's screen image on the TV. Power up both computer and TV before making any connections. Use a 15-pin D-sub display cable to connect a PC to the TV. *You must use audio inputs of side AV connection cable (RED & WHITE) to enable sound connection when connecting a device to your TV by using the PC input.* (fig.3). When the connection is made, switch "Source" to "PC-VGA". Set the resolution that suits your viewing requirements. Resolution information can be found in the "Appendix parts".

 **NOTE:** The cable is not supplied.

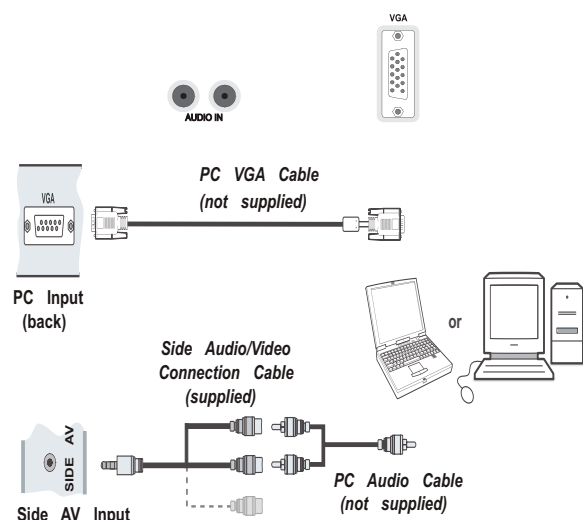

(fig. 3)

Connections

Side AV Connections

You must use the supplied SIDE AV connection cable for enabling SIDE AV connection.

1. Plug single jack of the cable to the TV's SIDE AV socket.
2. Insert your AV cable's (not supplied) connectors into the plural part of the SIDE AV connection cable (see illustration below). Colours of the connected jacks should match.
3. To enable audio connection, use an audio cable. Insert your device's audio cable's connectors into the plural part of the **SIDE AV connection cable**. Colours of the connected jacks should match (fig.1).
4. When the connection is made, switch to **FAV** source.

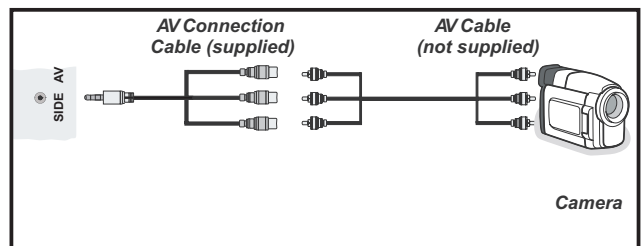

(fig.1)

Using a Conditional Access Module



IMPORTANT: Insert or remove the CI module only when the TV is SWITCHED OFF.

In order to watch certain digital channels, a conditional access module (CAM) can be necessary. This module must be inserted in the CI slot of your TV (fig. 2).

1. Obtain the Conditional Access Module (CAM) and the viewing card by subscribing to a pay channel company, then insert those to the TV using the following procedure.
2. Insert the CAM and then the viewing card to the slot that is located in the terminal cover at the rear side of the TV.
3. The CAM should be correctly inserted, it is impossible to insert fully if reversed. The CAM or the TV terminal may be damaged if the CAM is forcefully inserted.
4. Connect the TV to the mains supply, switch on and then wait for few moments until the card is activated.
5. When no module is inserted, “**No Common Interface module detected**” message appears on the screen.

You can refer to the module instruction manual for details of the settings.

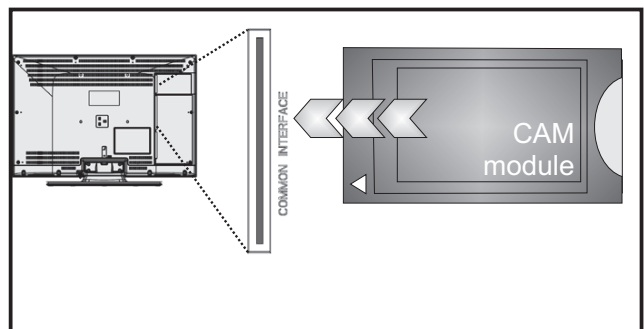

(fig.2)

Connections

USB Connections

2.5" and 3.5" inch (hdd with external power supply) external hard disk drives are supported.

IMPORTANT

You should back up your files before making any connections to the TV set in order to avoid any possible data loss. Note that manufacturer will not be responsible for any file damage or dataloss.

It is possible that certain types of USB devices (e.g. MP3 Players) or USB hard disk drives/memory sticks may not be compatible with this TV.

USB Disk Connection

Plug your USB device to the USB input of the TV.

NOTE:

Plug or unplug your USB disk while the TV is switched off.

If you are going to connect a USB hard disk drive to the TV set, USB connection cable used between the disk drive and the TV should have a USB logo and should be as short as possible.

While formatting a USB hard disk that has 1TB (Tera Byte) or more file capacity, you can experience problems with the formatting process. In such a case, you should format the disk with your personal computer and the formatted disk type should be FAT32.

CAUTION:

Quickly plugging and unplugging USB devices, is a very hazardous operation. Especially, do not repeatedly quickly plug and unplug the drive. This may cause physical damage to the USB player and especially the USB device itself. Do not pull out USB module while playing or recording a file.

Connections

Selecting source

Once you have connected external devices to the TV, you can select and change the input source required.

To change Input Selection, use one of the following options:

Option a: Press the **SOURCE** button on the remote control to directly select required source.

Option b: Select “**SOURCES**” from the “**Settings**” menu using the “**^**” or “**v**” button.

Use the “**^**” or “**v**” button to highlight the required input and press the “**>**” button to select.

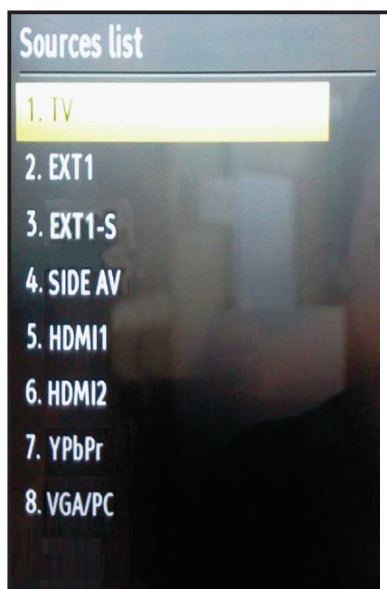

General TV Operation

Electronic programme guide (EPG)

Some, but not all channels send information about the current and next programmes. Press the EPG button to view the EPG menu.

Info bar commands:

RED button - Prev day: Displays previous day.

GREEN button - Next Day: Displays next day.

YELLOW button - Prev. day: Zooms to programmes.

INFO button - Details: displays, in detail information on programme selected.

SWAP button - Now: jumps to the current broadcast (when viewing previous “Prev. day” or future “Next day” programmes).

SUBT.: Selects genre.

Numeric buttons: Jump. Go to preferred channel directly using number buttons.

OK button : Displays programme options.

TELETEXT button - Search: to view “Guide Search” menu. Using this feature, you can search the programme guide database in line with the genre selected or with name match and on the day/s selected.

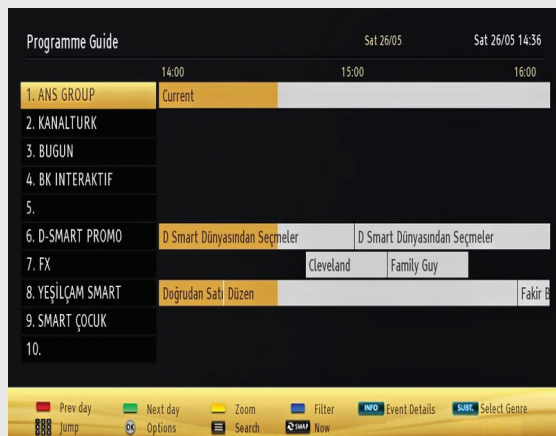

EPG screen in regular mode

General TV Operation



Basic Operations

Displaying Subtitles

With digital terrestrial broadcasting (DVB-T), some programmes are broadcasted with subtitles.

1. Press **MENU** button to display main menu, highlight "**Settings**" then "**Language Settings**" menu using "**<**" or "**>**" or "**^**" or "**v**" button, press **OK** button to display "Language settings" menu.

2. Highlight "**Subtitle**" in "**Language settings**" menu using "**^**" or "**v**" button. Use "**<**" or "**>**" button to set Subtitles to the desired language.

 **NOTE:** You can directly press **SUBTITLE** button to enable or disable subtitles. If "Subtitle" is On, pressing the  button causes a warning message to be displayed on the screen (** for UK only).

Zoom Modes

Programmes can be watched in different picture formats, depending on the transmission received.

You can change the aspect ratio (image size) of the TV for viewing the picture in different zoom modes.

Press **SCREEN** button repeatedly to change the image size. Available zoom modes are; 16:9, Subtitle, 14:9, 14:9 Zoom, 4:3, Panoramic and Cinema.

 **NOTE:** You can shift the screen up or down by pressing "**v**" / "**^**" buttons while picture zoom is selected as panoramic, 14:9 Zoom, Cinema or Subtitle. This is only possible as long as the display of the screen format is displayed.

Using Main Menu Screen

1. Press **MENU** button to display main menu, highlight the desired control icon using "**<**" or "**>**" or "**^**" or "**v**" button, press **OK** button to display menu contents.

2. Highlight an option inside a menu screen by using "**^**" or "**v**" button.

3. Use "**<**" or "**>**" button to set an option.

4. If "**OK**" box is displayed next to a menu setting, press "**OK**" to display sub-menu screen.

Changes are automatically stored. Press "**MENU**" to exit.

 **NOTE:** See **Picture, Sound, Settings and Installation Control** sections for learning the functions of menu items.

Configuring Date/Time Settings

1. Select **Date/Time** in the Settings menu to configure Date/Time settings.

2. Press **OK** button.

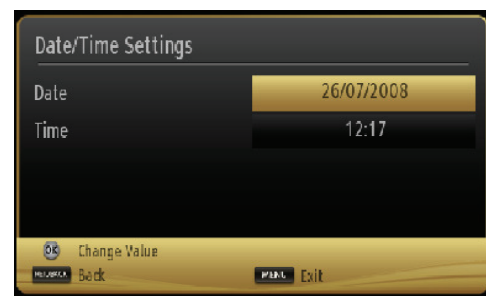

3. Use "**^**", "**v**" and "**<**", "**>**" buttons to set the options. Some items might be available to be set due to the selected modes.

Source Settings

You can enable or disable selected source options. When set, the TV will not switch to the disabled source options when "**SOURCE**" button is pressed.

1. Select "Sources" in the "Settings" menu and press "**OK**" button.

2. Press "**^**", "**v**" buttons to select a source.

3. Use "**<**", "**>**" button to enable or disable the selected source.

Current Language

(*) For digital broadcasts.

If there is a programme that is broadcasted with multi-channel sound or subtitles and offers different languages for these, you can choose the language. Press **LANG.** button to select between available options.

 **NOTE:** If the background is transparent, on screen texts will be slightly transparent as well.

General TV Operation

Channel Management

The TV sorts all stored stations in the Channel List. You can edit this channel list, set favourites or set active stations to be listed by using the Channel List options. Press **MENU** button to view main menu. Select Channel List item by using “**<**” or “**>**” button. Press **OK** to view menu contents.

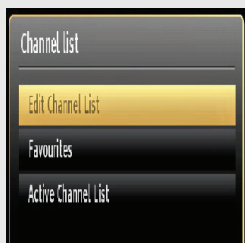

Select **Edit Channel List** to manage all stored channels. Use “**^**” or “**v**” and **OK** buttons to select “**Edit Channel List**”.



Note: The channels listed are mixed at the channel list. Channel types can be differentiated by the icons next to them: DTV (digital tv), HD (HD TV), ATV (Analogue TV), TV (TV), RD (Radio), encrypted, lock, and at the favourite list.

Navigating Channel List

1. Press “**^**” or “**v**” button to select previous or next channel. Press **P+** or **P-** button to move up or down the page.
2. To watch a specific channel, highlight the “**OK**” box on Channel List menu using “**<**” or “**>**” button.

Moving a Channel

1. Select the desired channel.
2. Select **Move** box in the channel list and press **OK** button.

3. Edit Number screen will be displayed. Enter the desired channel number by using the numeric buttons on the remote control.

 **NOTE:** If there is a previously stored channel on that number, a warning screen will be displayed.

4. Select **Yes** if you want to move the channel and press **OK**.

Deleting a Channel

1. Select the channel that you want to delete and select **Delete** box.
2. Press **OK** button to continue. A warning screen will appear. Select **YES** to delete, select **No** to cancel. Press **OK** button to continue.

Renaming a Channel

1. Select the channel that you want to rename and select **Edit Name** box. Press **OK** button to continue.
2. Use navigation buttons to toggle between the current character, i.e., ‘b’ character becomes ‘a’ by “**v**” and ‘c’ by “**^**”.
3. When finished, press **OK** button to save. Press **MENU** to cancel.

Locking a Channel

1. Select the channel that you want to lock and select **Lock** option. Press **OK** button to continue.
2. You will be asked to enter parental control PIN. Default PIN is set as **0000**. Enter the PIN number.
3. The desired channel is locked (Lock symbol is displayed next to the selected channel) or unlocked.

Button Functions

- OK:** Add/remove a station.
- YELLOW:** Tag/untag a channel.
- GREEN:** Tag/untag all channels.
- BLUE:** Displays filtering options.

Sorting Channel List

You can select broadcasts to be listed in the channel list. To display specific types of broadcast, you should use Active channel list setting.

Select Active channel list from the Channel list menu by using “**^**” or “**v**” button. Press **OK** button to continue. You can select a network type option from the list by using “**<**” or “**>**” and **OK** buttons.

General TV Operation

Favourite Mode & Timers

Favourite Mode

You can create a list of favourite programmes using the favourites feature. In such a case, only the favourite channels are navigated.

1. Press “**MENU**” button to view main menu.
2. Select Channel List item by using “**<**” or “**>**” button.
3. Press “**OK**” to view menu contents.
4. Use “**^**” or “**v**” and “**OK**” buttons to select “Favourites”.

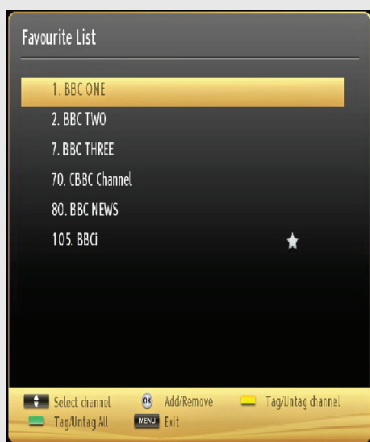

5. Select a channel by using “**^**” or “**v**” button.
6. Press “**OK**” button to add selected channel to favourites list. Press “**OK**” button again to remove.

Button Functions

OK: Add/remove a station.

YELLOW: Tag/untag a channel.

GREEN: Tag/untag all channels.

MENU: Exit.

Conditional Access

If you have inserted a conditional access module and viewing card to your TV, you can use Conditional Access menu. Note that these menu settings may change depending on the service provider.

1. Press “**MENU**” button and select the “Settings” icon by using “**<**” or “**>**” button.
2. Press “**OK**” button to view Settings menu.

3. Use “**^**” or “**v**” button to highlight **Conditional Access** and press “**OK**” to view menu items.

Setting Sleep Timer

This setting is used for setting the TV to turn off after a certain time.

1. Press “**MENU**” button and select the “Settings” icon by using “**<**” or “**>**” button.
2. Press “**OK**” button to view Timers menu.
3. Highlight Sleep Timer by using “**^**” or “**v**” button.
4. Use “**<**” or “**>**” button to set. The timer can be programmed between **Off** and **2.00** hours (120 minutes) in steps of 30 minutes.

Setting Programme Timers

You can set programme timers for a particular programme using this feature.

1. While in Timers menu, press “**v**” button to activate timers functions.
2. Programme timer function buttons will be displayed on the screen.
3. Press **YELLOW** button on the remote control to add a timer. Timer options and definitions are as the following:

Network Type: This feature is unavailable to be set.

Timer Type: You can select timer type as Record or Timer.

Channel: Changes channel by using “**<**” or “**>**”.

Record Type: This item is unavailable to be set.

Date: Enter a date using the numeric buttons.

Start: Enter a starting time using the numeric buttons.

End: Enter an ending time using the numeric buttons.

Duration: Displays duration between the starting and ending time.

Repeat: Sets a timer to be repeated as Once, Daily or Weekly. Use “**<**” or “**>**” buttons to select an option.

Change/Delete: Sets the change/delete permission.

General TV Operation

Timers - continued & Power Save Mode

Playback: Sets the playback permission and parental settings.

4. Press **GREEN** button to save the timer. Press **RED** button to cancel.

Editing a Timer

1. Select the timer you want to edit by pressing “**^**” or “**v**” button.

2. Press “**GREEN**” button. Edit Timer menu screen will be displayed.

3. When finished with editing, press “**OK**” button to save. You can press “**RET/BACK**” button to cancel.

Deleting a Timer

1. Select the timer you want to delete by pressing “**^**” or “**v**” button.

2. Press **RED** button.

3. Select **YES** by using “**◀**” or “**▶**” buttons to delete the timer. Select **NO** to cancel.

Power Save Mode

This television is designed to consume less energy to save environment. You not only help to save the environment but also you can save money by reducing electricity bills thanks to the energy efficiency feature of this TV. To reduce energy consumption, you should take the following steps:

You can use Power Save Mode setting, located in the Picture Settings menu. If you set Power Save Mode as **Eco**, the TV will switch to energy-saving mode and luminance level of TV set will be decreased to optimum level. Note that some picture settings will be unavailable to be changed when the TV is in Power Save Mode.



If Picture Off is selected, “**Screen will be off in 15 seconds.**” message will be displayed on the screen. Select **PROCEED** and press **OK** to continue. The screen will be off in 15 seconds. If you disable Power Save Mode, Picture mode will be automatically set to Dynamic.

When the TV is not in use, please switch off or disconnect the TV from the mains socket. This will also reduce energy consumption.

Disconnect power when going away for longer time.

It is highly recommended to activate Power Save Mode setting to reduce your annual power consumption. Also it is recommended to disconnect the TV from the mains socket to save energy more when you do not use.

Please help us to save environment by following these steps.

Repair Information

Please refer all servicing to qualified personnel. Only qualified personnel must repair the TV. Please contact your local dealer, where you have purchased this TV for further information.

General TV Operation

Picture Controls

Configuring Picture Settings

You can use different picture settings in detail.

Press “**MENU**” button and select the Picture icon by using “**<**” or “**>**” button. Press **OK** button to view Picture Settings menu.

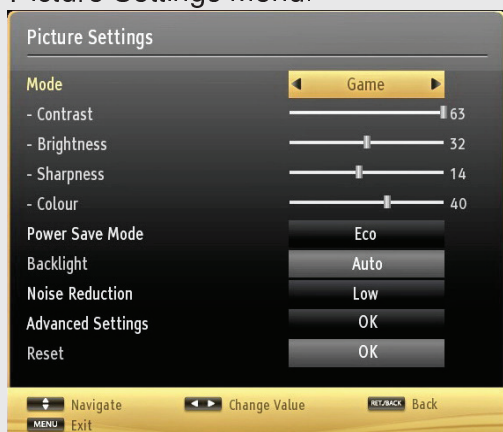

Operating Picture Settings Menu Items

Press “**^**” or “**v**” button to highlight a menu item.

Use “**<**” or “**>**” button to set an item.

Press “**MENU**” button to exit.

Picture Settings Menu Items

Mode: For your viewing requirements, you can set the related mode option. Picture mode can be set to one of these options: **Cinema, Game, Dynamic, Sport** and **Natural**.

Contrast: Sets the lightness and darkness values of the screen.

Brightness: Sets the brightness value for the screen.

Sharpness: Sets the sharpness value for the objects displayed on the screen.

Colour: Sets the colour value for the screen.

Power Save Mode : Press “**<**” or “**>**” button to set Power Save Mode.

If Picture Off is selected, “**Screen will be off in 15 seconds.**” message will be displayed on the screen. Select **PROCEED** and press **OK** to continue. The screen will be off in 15 seconds. If you disable Power Save Mode, Picture mode will be automatically set to **Dynamic**.

 **NOTE:** The backlight function will be inactive if Power Save Mode is set to **Eco**.

Backlight : This setting controls the backlight level and it can be set to Auto, Maximum, Minimum or Medium.

 **NOTE:** Backlight can not be activate in **VGA** or **Media Browser** mode or while picture mode is set as **Game**.

Noise Reduction: If the broadcast signal is weak and the picture is noisy, use **Noise Reduction** setting to reduce the noise amount. Noise Reduction can be set to one of these options: **Low, Medium, High** or **Off**.

Advanced Settings

- **Dynamic Contrast:** Sets the dynamic contrast rate.

- **Colour Temp:** Sets the desired colour tone.

Setting **Cool** option gives white colours a slight blue stress.

For normal colours, select **Normal** option.

Setting **Warm** option gives white colours a slight red stress.

- **Picture Zoom:** Sets the picture size to **Auto, 16:9, Subtitle, 14:9, 14:9 Zoom, 4:3, Panoramic** or **Cinema**.

- **HDMI True Black:** While watching from HDMI source, this feature will be visible in the Picture Settings menu. You can use this feature to enhance blackness in the picture. You can set this feature as “**On**” for activating HDMI True Black mode.

- **Film Mode (optional):** Films are recorded at a different number of frames per second to normal television programmes. Press “**<**” or “**>**” buttons to set this feature Auto or Off. Turn this feature to Auto when you are watching films to see the fast motion scenes clearly.

- **Skin Tone:** Sets the skin tone level of your TV.

- **Colour Shift:** Adjust the desired colour tone.

- **RGB Gain:** You can configure the colour temperature values using the RGB Gain feature.

Reset: Resets the picture settings to factory default settings.

While in **VGA (PC)** mode, some items in Picture menu will be unavailable. Instead, **VGA** mode settings will be added to the Picture Settings while in **PC** mode.

General TV Operation

PC Picture Controls

PC Picture Settings Operation

For adjusting PC picture items, do the following:

Press “<” or “>” button to select Picture icon. Picture menu appears on the screen.

Contrast, Brightness, Colour, Colour Temp and Picture Zoom, Reset settings in this menu are identical to settings defined in TV picture settings menu. **Sound ,Settings and Source settings are identical to the settings explained in the main menu system.**

PC Position: Select this to display PC position menu items.

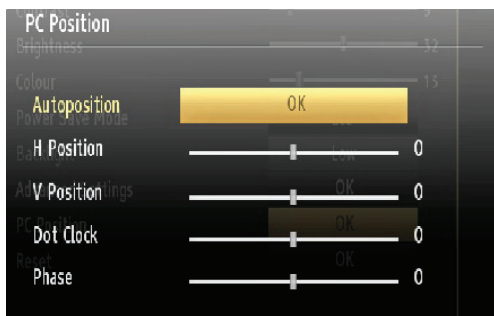

Autoposition: Automatically optimizes the display. Press **OK** to optimize.

H Position: This item shifts the image horizontally to right hand side or left hand side of the screen.

V Position: This item shifts the image vertically towards the top or bottom of the screen.

Dot Clock: Dot Clock adjustments correct the interference that appear as vertical banding in dot intensive presentations like spreadsheets or paragraphs or text in smaller fonts.

Phase: Depending on the resolution and scan frequency that you input to the TV set, you may see a hazy or noisy picture on the screen. In such a case you can use this item to get a clear picture by trial and error method.

Quick Menu

The Quick Settings menu allows you to access some options quickly. This menu includes **Power Save Mode, Picture Mode, Equalizer Settings, Favourites, Sleep Timer, FollowMe TV to DMR, CEC RC Passthrough, FollowMe TV** (optional) and **Information booklet** options. Press **Q.MENU** button on the remote control to view the quick menu. See the following chapters for details of the listed features.

FollowMe TV (optional)

With your tablet you can stream the current broadcast from your smart TV using the **FollowMe TV** feature. Install the appropriate application to your tablet PC. Start the application.

For further information on using this feature refer to the instructions of the application you use.

FollowMe TV to DMR (optional)

This feature allows video streaming from your TV to another TV or mobile devices, using proper applications (e.g. UPnP - Universal Plug and Play - applications like BubbleUPnP). Activate FollowMe TV to DMR and timeshifting starts. Press the red button and device selection menu will be displayed. Choose your device and press OK.

Note: FollowMeTV and FollowMe TV to DMR features work correlated with the PVR feature and requires a connected USB storage device with FAT32 format and enough space in it. HD channels are not supported and both of the devices must be connected to the same network.

E-Manual

You can find instructions for your TV's features in the E-Manual.

To use E-Manual, press to the **Info button** while main menu is displayed on the screen.

By using the navigation buttons select a desired category. Every category includes a different topics. Select a topic and press **OK** to read instructions.

To close the E-Manual screen press the **Exit** button.

Note: The contents of the E-Manual may vary according to model.

General TV Operation

CEC and CEC RC Passthrough

This function allows to control the CEC-enabled devices, that are connected through HDMI ports by using the remote control of the TV.

The CEC option in the Other Settings menu under Settings menu should be set as Enabled at first. Press the Source button and select the HDMI input of the connected CEC device from the Source List menu. When new CEC source device is connected, it will be listed in source menu with its own name instead of the connected HDMI ports name(DVD Player, Recorder 1 etc.).

The TV remote is automatically able to perform the main functions after the connected HDMI source has been selected.

To terminate this operation and control the TV via the remote again, press and hold the "0-Zero" button on the remote control for 3 seconds. Or press Q.Menu button on the remote, highlight the CEC RC Passthrough and set as Off by pressing Left or Right button. This feature can also be enabled or disabled under the Settings/ Other Settings menu.

The TV supports also ARC(Audio Return Channel) feature. This feature is an audio link meant to replace other cables between the TV and the audio system (A/V receiver or speaker system).

When ARC is active, TV does not mute its other audio outputs automatically. So you need to decrease TV volume to zero manually, if you want to hear audio from connected audio device only (same as other optical or co-axial digital audio outputs). If you want to change connected device's volume level, you should select that device from the source list. In that case volume control keys are directed to connected audio device.

General TV Operation

Sound & Source Controls

Configuring Sound Settings

Sound settings can be configured according to your personal preferences.

Press “**MENU**” button and select the first icon by using “**<**” or “**>**” button. Press **OK** button to view Sound Settings menu.



Operating Sound Settings Menu Items

Press “**^**” or “**v**” button to highlight a menu item.

Use “**<**” or “**>**” button to set an item.

Press “**MENU**” button to exit.

Sound Settings Menu Items

Volume: Adjusts volume level.

Equalizer: Press **OK** button to view equalizer sub-menu.

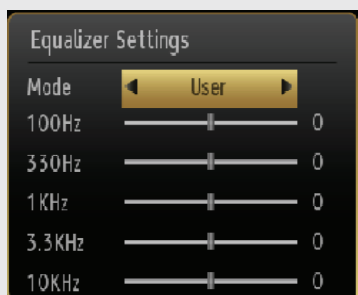

In the equalizer menu, the preset can be changed to **Music, Movie, Speech, Flat, Classic** and **User**. Press the “**MENU**” button to return to the previous menu.

NOTE: Equalizer menu settings can be changed manually only when the **Equalizer Mode** is in **User**.

Balance: This setting is used for emphasizing left or right speaker balance.

Headphone: Sets headphone volume.

Sound Mode: You can select Mono, Stereo, Dual I or Dual II mode, only if the selected channel supports that mode.

AVL: Automatic Volume Limiting (AVL) function sets the sound to obtain fixed output level between programmes (For instance, volume level of advertisements tend to be louder than programmes).

Headphone/Lineout (optional): When you connect an external amplifier to your TV using the headphone jack, you can select this option as Lineout. If you have connected headphones to the TV, set this option as Headphone.

Dynamic Bass: Enables or disables the Dynamic Bass.

SRS TruSurround HD: Press “**<**” or “**>**” button to set SRS TruSurround HD as on or off. If you set SRS TruSurround HD as On, some features in the Sound menu can be unavailable to be set.

Digital Out: Sets digital out audio type.

Configuring Source Settings

You can enable or disable selected source options. The TV will not switch to the disabled source options when “**SOURCE**” button is pressed.

Press “**MENU**” button and select Settings icon by using “**<**” or “**>**” button. Press **OK** button to view **Settings** menu. Select Source and press **OK** button.

Select **Sources** in the Settings menu and press **OK** button.



Press “**<**” or “**>**” buttons to select a source.

Use “**<**” or “**>**” button to enable or disable the selected source. Changes are automatically stored.

Press **RED** button to edit the name of the selected source.

To view general configuration preferences, select **Other Settings** in the Settings menu and press **OK** button.

General TV Operation

Other Controls

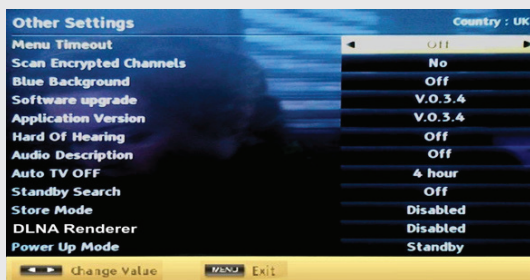

Operation

Press “ \wedge ” or “ \vee ” buttons to select an item.

Use “ \langle ” or “ \rangle ” button to set an option.

Press **OK** button to view a sub-menu.

Other Settings Menu Items

Menu Timeout: Changes timeout duration for menu screens.

Active Antenna (optional): This feature enables or disables the use of active antennas. When antenna power option is set as On, +5V will be transmitted to the antenna output.

 **IMPORTANT:** Antenna power should be Off when standard antenna is used instead of the active antenna.

Scan Encrypted Channels: When this setting is set as **YES**, search process will locate the encrypted channels as well. If it is set as **NO**, encrypted channels will not be located in automatic search or manual search.

Blue Background: Activates or deactivates blue background system when the signal is weak or absent.

Software Upgrade: To ensure that your TV always has the most update information, you can use this setting. In order for the proper operation, please ensure that the TV is set to standby mode.

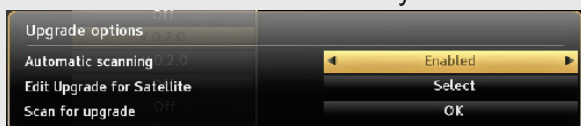

You can enable or disable automatic upgrade by setting **Automatic Scanning** option.

You can manually search for new software by selecting **Scan for upgrade**.

Application version: Displays the current application version.

Hard of Hearing: If the broadcaster enables any special signal concerning the audio, you can set this setting as On to receive such signals.

Audio Description: Audio description refers to an additional narration track for blind and visually impaired

viewers of visual media, including television and movies. The description narrator talks through the presentation, describing what is happening on the screen during the natural pauses in the audio (and sometimes during dialogue, if deemed necessary). You can use this feature, only if the broadcaster supports that additional narration track.

Auto TV Off: You can set the timeout value of auto off feature. After the timeout value is reached and the TV is not operated for selected time, the TV will go off.

Standby Search (optional): Use “ \wedge ” or “ \vee ” button to select Standby Search and then press “ \langle ” or “ \rangle ” button to set this setting as On or Off. If you change Standby Search to Off, this function will be unavailable. To use Standby search please make sure that you select Standby Search as On.

Store Mode: You can activate Store mode option by using “ \langle ” or “ \rangle ” button. If you are displaying the TV in a store, you can activate this mode. While Store Mode is enabled, some items in the TV menu may not be available to be set.

DLNA Renderer: DLNA Renderer feature allows you to share files stored on your smartphone. If you have a DLNA Renderer compatible smartphone and software installed, you can share/play photos with your TV. Use “ \langle ” or “ \rangle ” button to enable or disable DLNA Renderer. See instructions of your sharing software for more information.

Power Up Mode: This setting configures the power up mode preference. Use “ \langle ” or “ \rangle ” button to set.

Always On: The TV always switches on when main on/off button is pressed.

Standby: The TV always powers up in Standby mode.

Last State: The TV always switches on with the last selected channel/source.

Virtual Remote (optional): Enables or disables the virtual remote feature.

CEC: With this setting you can enable and disable CEC functionality completely. Press Left or Right button to enable or disable the feature.

Netflix: You can view your ESN(*) number and deactivate Netflix. (*) ESN number is an unique ID number for Netflix, created especially to identify your TV.

General TV Operation

Language Settings

You can operate the TV's language settings using this menu.

Press "**MENU**" button and select the Settings icon by using "<" or ">" button. Press **OK** button to view Settings menu. Use "▲" or "▼" button to highlight **Language** and press **OK** to continue:



Use "▲" or "▼" button to set an item. Settings are stored automatically.

Menu: displays the system language.

Preferred

These settings will be used if available. Otherwise the current settings will be used.

Audio: Sets the preferred audio language.

Subtitle: Sets the subtitle language. Selected language will be seen in subtitles.

Teletext: Sets teletext language.

Guide: Sets the preferred Guide language.

Current (*)

() These settings can be changed if only the broadcaster supports. Otherwise, settings will not be available to be changed.*

Audio: Changes the audio language for the current channel.

Subtitle: Sets the subtitle language for the current channel.



NOTE: If the Country option is set to Denmark, Sweden, Norway or Finland, the Language Settings menu will function as described below:

Language Settings



In the configuration menu, highlight the Language Settings item by pressing "▲" or "▼" buttons. Press **OK** and Language Settings submenu will be displayed on the screen:

Use "▲" or "▼" buttons to highlight the menu item that will be adjusted and then press "<" or ">" button to set.



NOTE:

System Language determines the on-screen menu language.

Audio Language is used for selecting the soundtrack of a channels.

Primary settings are the first priority when multiple choices are available on a broadcast. Secondary settings are the alternatives when the first options are not available.

General TV Operation

Media Browser

Only available when a USB device is plugged into the TV.

Starting Media Browser

1. Press **MENU** button on the remote control and select “**Media Browser**” pressing “**<**” or “**>**” button.

2. Press **OK** button to continue.

You can plug in two USB devices at the same time to your TV. If both USB devices include music, images and video, the USB Selection screen appears.

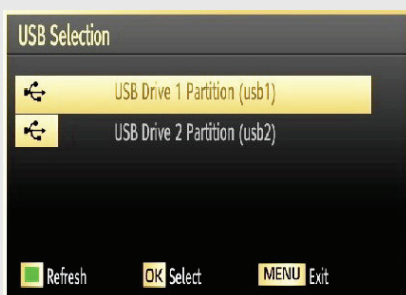

The USB device which is connected first to the TV set will be known as a USB Drive 1.

3. Use the “**^**” or “**v**” button to select a device and press **OK**. Media Browser menu contents (depending on the contents of your USB drive) will be displayed. You can play music, picture and video files from the connected USB memory stick.

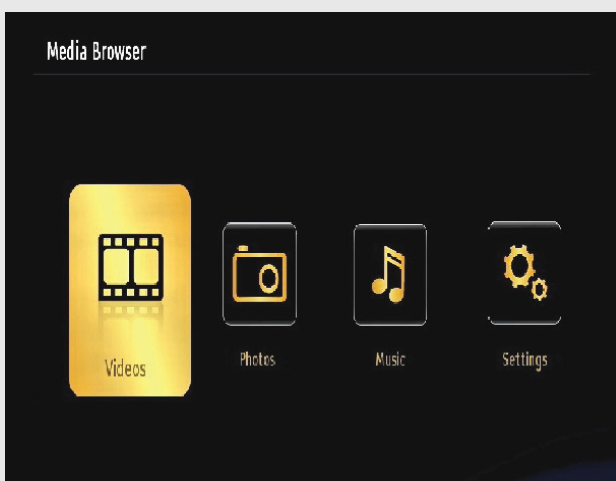

Media Browser Configuration

Select Settings icon from the main media browser page to view the current preferences.



You can set your Media Browser preferences by using the Settings dialogue.

Operation

Press “**^**” or “**v**” button to highlight an item.

Use “**<**” or “**>**” button to configure an item.

View Style

Sets default browsing mode. Sets default browsing mode as folder or flat. Select “Directory” to display files in a folder or “Normal” to view files directly. If you select the view style “Directory” the menu point “All” will appear in the media browser (See the section: Media playback using media browser). The option “All” gives you an overview of the directories images, music, videos.

Slide Show Interval

Sets slide show interval time.

Show Subtitle

Sets subtitle enabling preference.

Subtitle Language

Sets supported subtitle language.

Subtitle Position

Sets subtitle position as up or down.

Subtitle Font Size

Sets subtitle font size (max. 54pt).

General TV Operation

Media Browser - continued

Viewing Videos via USB

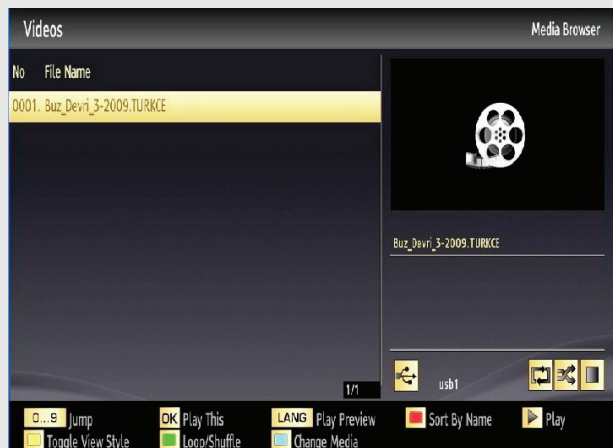

1. Select **Videos** from the **Media Browser** screen and press **OK** button.
2. All video files will be filtered and listed.
3. Use “**^**” or “**v**” button to select a video file and press **OK** button to play a video. Follow the information on the operations bar for using other commands.

Video Playback Screen

The following screen will be displayed while playing a video file.

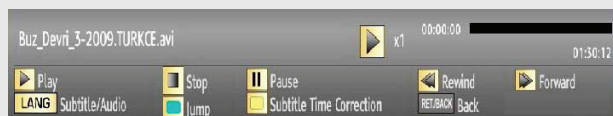

Subtitle Time Correction

Press **YELLOW** button during the video playback for activating **Subtitle Time Correction** screen.

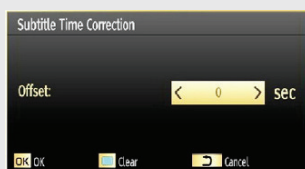

1. Enter an offset value using “**<**” or “**>**” button.
2. Press **YELLOW** button to confirm or press **RETURN** button to switch back to previous menu.

Viewing Photos via USB

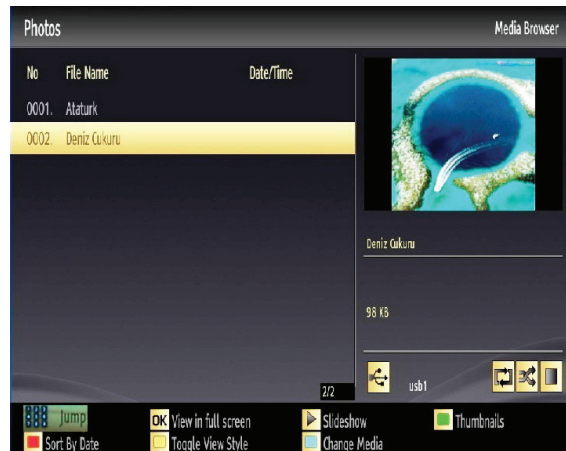

1. Select **Photos** from the **Media Browser** screen and press **OK** button. All photo files will be filtered and listed.
2. Use “**^**” or “**v**” button to select a photo file and press **OK** button to play a video. Follow the information on the operations bar for using other commands.

Displaying Photos in Slideshow Mode

1. Press **▶** (PLAY) button when viewing photo files to activate slideshow mode.

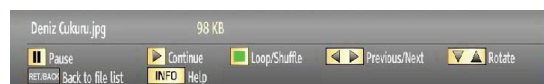

2. Press **RETURN** to go back to Photos screen. Follow the information on the operations bar for using other commands.

Playing Music via USB



1. Select **Music** from the **Media Browser** screen and press **OK** button. All music files will be filtered and listed.

General TV Operation

Media Browser - continued

2. Use “**^**” or “**v**” button to select a music file and press **OK** button to play. Follow the information on the operations bar for using other commands.

Using **MENU** button in Media Browser Mode

Pressing **MENU** button in Media Browser mode displays the following menu screen:

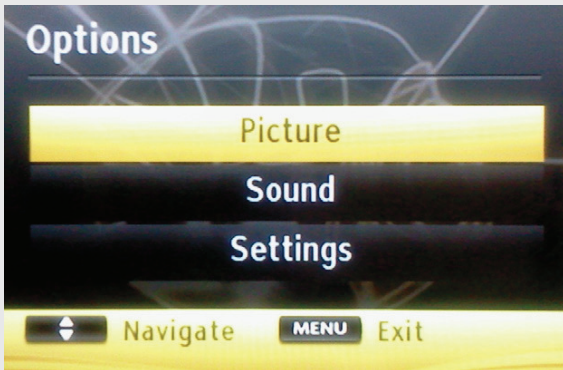

You can access **Picture**, **Sound** and **Settings** menu options using this screen. Press **MENU** again to exit from this screen.

General TV Operation

Installation Controls

Accessing Installation Menu

1. Press “**MENU**” button on the remote control and select **Installation** by using “**<**” or “**>**” button.
2. Press “**OK**” button and the **Installation** screen will be displayed.

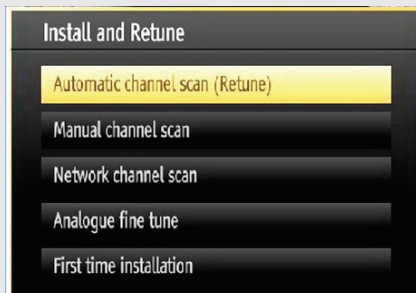

Automatic Channel Scan (Retune)

1. In the Installation menu, select “**Automatic Channel Scan (Retune)**” by using “**^**” or “**v**” button and press **OK** button.
2. Options will be displayed. You can select options by using “**^**” or “**v**” and **OK** buttons.

Menu Operations

Digital Aerial: Searches and stores aerial DVB stations.

Digital Cable: Searches and stores cable DVB stations.

Analogue: Searches and stores analogue stations

Digital Aerial & Analogue: Searches and stores aerial DVB and analogue stations.

Digital Cable & Analogue: Searches and stores cable DVB and analogue stations.

3. Whenever you select an automatic search type and press **OK** button, a confirmation screen will appear on the screen. To start installation process, select **Yes**, to cancel select **No** by using “**<**” or “**>**” and “**OK**” button.
4. After auto channel scan type is set and selected and confirmed, installation process will start and progress bar will move along. If desired, press “**MENU**” button to cancel process. In such a case, located channels are not stored.

Manual Channel Scan

1. In the Installation menu, select “Manual Channel Scan” by using “**^**” or “**v**” button and press **OK** button.
2. Manual Scan options screen will be displayed. Select the desired “Search Type” using “**<**” or “**>**” button. Manual search options will change accordingly.

3. Enter the multiplex (for digital manual search), frequency, polarization, symbol rate, network channel scan, satellite options (for satellite manual search) or frequency number (for analogue manual search) using the numeric buttons and press **OK** button to start search.

Network Channel Scan

1. Select Network Channel Scan from the installation menu by using “**^**” or “**v**” and press **OK** button. 2. Network Channel Scan selection screen will be displayed. Select Digital Aerial or Digital Cable and press **OK** button to continue. Refer to the **Initial Installation** section for more information on the process.

Analogue Fine Tune

1. Select “Analogue Fine Tune” from the Installation menu by using “**^**” or “**v**” and **OK** buttons. Analogue fine tune screen will be displayed.



NOTE: Analogue Fine Tune feature will not be available if there are no analogue channels, digital channels and external sources stored.

2. Press **OK** button to proceed. Use “**<**” or “**>**” button to set Fine Tune. When finished, press **OK** button again.

First Time Installation

Deletes all stored channels and settings, resets TV to factory settings and starts first time installation.

1. Select **First Time Installation** option and press **OK** button if you would like to reset the TV.
2. A warning screen will be displayed. Select **YES** and press **OK** to continue. All prestored channels and settings will be deleted in such a case.
3. The TV will reset after a short time and language selection menu will be displayed.
4. Follow the steps in the **Initial set up** section.

Clear Service List

(* This setting is visible only when the Country option is set to Denmark, Sweden, Norway or Finland.

1. Use this setting to clear channels stored. Press “**^**” or “**v**” button to select **Clear Service List** and then press **OK**.
2. An OSD message will be displayed on the screen. Press **OK** to cancel or select Yes to delete all of the stored channels.

General TV Operation

Parental Control

To prohibit viewing of certain programmes, channels and menus can be locked by using the parental control system. This function enables or disables the menu protection system and allows the PIN code to be changed.

1. Press “**MENU**” button and select the Settings icon by using “**<**” or “**>**” button.

2. Press **OK** button to view Settings menu. Use “**^**” or “**v**” button to highlight Parental and press “**OK**” to continue:

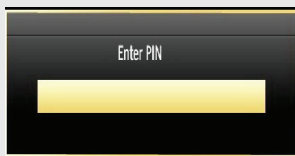

3. To display parental lock menu options, PIN number must be entered. Factory default PIN number is **0000**. After coding the correct PIN number, parental settings menu will be displayed:

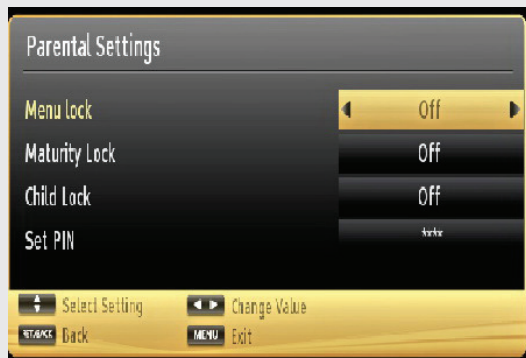

Parental Settings Menu Operation & Items

Select an item by using “**^**” or “**v**” button. Use “**<**” or “**>**” button to set an item. Press **OK** button to view more options.

Menu Lock: Menu lock setting enables or disables the menu access. You can disable access to the installation menu or the whole menu system.

Maturity Lock (not available for the UK): When set, this option gets the maturity information from the broadcast and if this maturity level is disabled, disables access to the broadcast.

Child Lock: When Child Lock is set, the TV can only be controlled by the remote control. In this case the control panel buttons will not work, except for the Standby Off/On button. When Child Lock is activated you are able to switch the TV into Standby mode with the Standby Off/On button. To switch the TV on again, you need the remote control. Hence, if one of those buttons is pressed, **Child Lock Is On** will be displayed on the screen when the menu screen is not visible.

Set PIN: Defines a new PIN number. Use numeric buttons to enter a new pin number. You will need to code your new pin a second time for verification purposes.



IMPORTANT: The factory default pin number is **0000** (except for the France), if you change the pin number make sure you write it down and keep it safe.

General TV Operation

Teletext

Analogue Teletext

Teletext system transmits information such as news, sports and weather on your TV. Note that if the signal degrades, for example in poor/adverse weather conditions, some text errors may occur or the teletext mode may be aborted.

Analogue Teletext



Teletext function buttons are listed below:

“” Teletext / Mix : Activates teletext mode when pressed once. Press again to place the teletext screen over the programme (mix). Pressing again will quit the teletext mode.

“**RETURN**” Index: Selects the teletext index page.

“**INFO**” Reveal: Shows hidden information (e.g. solutions of games).

“**OK**” Hold: Holds a text page when convenient. Press again to resume.



“” or “” Subcode Pages : Selects subcode pages if available when the teletext is activated.

P+ / P- and numbers (0-9): Press to select a page.

Note: Most TV stations use code 100 for their index pages.

Coloured Buttons

(RED/GREEN/YELLOW/BLUE)

Your TV supports both **FASTTEXT** and **TOP text** systems. When these systems are available, the pages are divided into groups or topics. When **FASTTEXT** system is available, sections in a teletext page will become colour-coded and can be selected by pressing the coloured buttons. Press a coloured button that corresponds to with your needs. The coloured writings will appear, showing you which coloured buttons to use when **TOP text** transmission is present. Pressing “” or “” commands will request the next or previous page respectively.

Digital Teletext (for the UK only)

1. Press the “” button. The digital teletext information appears on screen.

2. Operate using the coloured buttons, cursor buttons and **OK** button.

The operation method may differ depending on the contents of the digital teletext.

3. Follow the instructions displayed on digital teletext screen.

When “Press **OK** button” or similar message appears on the screen, press **OK** button.

When the “” button is pressed, the TV returns to television broadcasting.

When you press the “” button again, the digital teletext screen will be displayed

Connectivity Functions

Connecting to a Wired Network

For connecting to a wired LAN network, you should perform the following steps:

- Connect broadband ISP connection ethernet cable to the ETHERNET INPUT of your modem.
- Ensure that Nero Media Home software is installed to your PC.(for DLNA function). See Appendix G for more information on the installation process.
- Afterwards, you should connect your PC to the one of your modem's LAN connectors (e.g. LAN 1) by using a proper LAN cable.
- Use another LAN output of your modem (e.g. LAN 2) to enable the connection to your TV. You can add your TV to your LAN by connecting the LAN port at the rear of your TV to your modem's LAN connector as illustrated (fig.1).
- To access and play shared files, you must Select Media Browser. Press Menu button and select Media Browser by using Left or Right button. Press OK to continue. Select the desired file type and press OK. You must always use the Media Browser screen to access and play shared network files.
- PC/HDD/Media Player or any other devices that are DLNA 1.5 compatible should be used with wired connection for higher playback quality.

To configure wired settings please refer Network Settings section in Settings menu.

- You might be able to connect your TV to your LAN network depending on your network's configuration. In such a case, use an ethernet cable to connect your TV directly to the network wall outlet (fig.2).

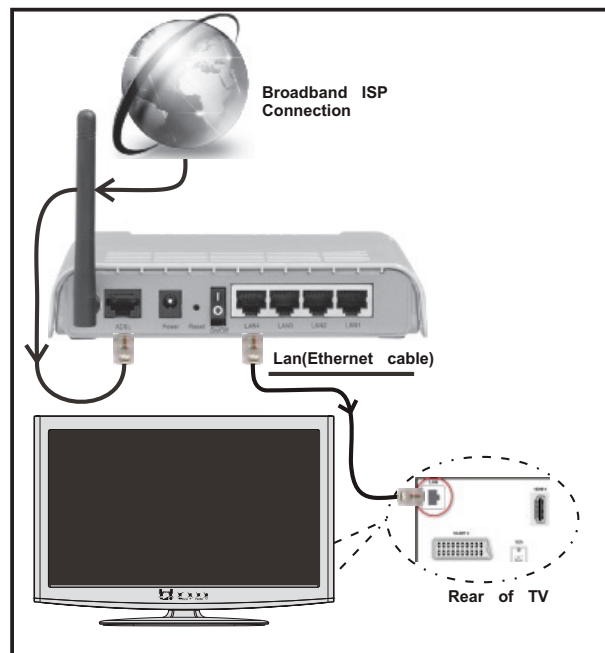

fig.1

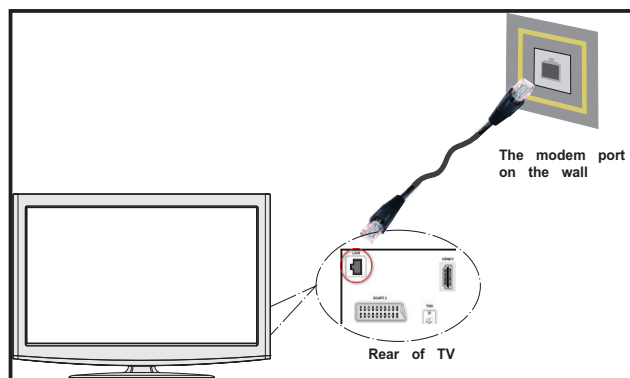

fig.2

Connectivity Functions

Connecting to a Wireless Network

IMPORTANT: “Veezy 200” USB dongle (supplied with your TV) is required to use wireless network feature.

- To use your TV with your wireless network, you need a Veezy 200 Wireless USB dongle. To make your modem’s SSID visible, you should change your SSID settings via modem’s software. The TV cannot connect to the networks with hidden SSID.

For connecting to a wireless LAN network, you should perform the following steps:

1. Connect broadband ISP connection ethernet cable to the ETHERNET INPUT of your modem.
2. Ensure that Nero Media Home software is installed to your PC (for DLNA function).
3. Afterwards, you should connect wireless adaptor to one of the USB inputs of the TV.
4. To configure wireless settings please refer Network Settings section in the following sections.

- A Wireless-N router (IEEE 802.11a/b/g/n) with simultaneous 2.4 and 5 GHz bands designed to increase bandwidth. Optimized for smoother and faster HD video streaming, file transfers, and wireless gaming.

- Use LAN connection for quicker file sharing between other devices like computers.

- The frequency and channel differ depending on the area.

- The transmission speed differs depending on the distance and number of obstructions between the transmission products, the configuration of these products, the radio wave conditions, the line traffic, and the products that you use. The transmission may also be cut off or get disconnected depending on the radio wave conditions DECT phones, or any other WiFi 11b appliances. The standard values of the transmission speed are the theoretical maximum values for the wireless standards. They are not the actual speeds of data transmission.

- The location where the transmission is most effective differs depending on the usage environment.

- Wireless LAN adaptor should be connected directly to the TV’s USB port. USB hubs are not supported.

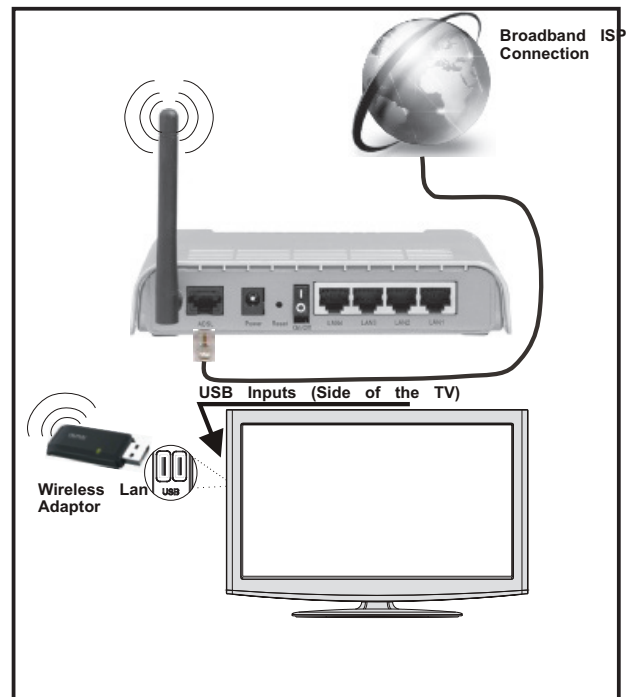

fig.1

- To configure wireless settings please refer wifi section in Settings menu.

- Wireless LAN adaptor supports 802.11 a,b,g & n type modems. It is highly recommended that you should use IEEE 802.11n communication protocol in order to avoid any possible problems while watching videos.

- Use the other usb input, if you experience problems with audio/video performance.

- You must change your modem’s SSID when there are any other modems around with the same SSID. You can encounter connection problems otherwise. Use wired connection instead if you experience problems with wireless connection.

Connectivity Functions

Configuring Network Settings

Your TV's Network Settings include *Wired* and *Wireless Connection* options. However, if your TV does not have *USB Wi-Fi dongle (supplied with your TV)*, you should use *Wired Connection type*. If you try to connect via *Wireless Connection* when your TV does not have a *USB Wi-Fi dongle*, a warning screen will appear and the TV will not get an IP address. Try connecting the LAN cable after this and then the TV will be able to get an IP address.

Configuring Wired Device Settings

If you are connecting the TV via *ETHERNET INPUT*, select Network Type as **Wired Device** to configure.



Network Type

Network type can be selected as **Wired** or **Wireless** device, in accordance with the active connection to the TV set. Select this as **Wired** if you have connected to the TV a LAN cable. Select as **Wireless** if you connect via the wireless USB dongle (*supplied with your TV*).

Configuration Status

This section displays the status of the connection. Select **Connected** if you want to activate connection. Select as **Not Connected** to end an active connection.

IP Address

If an active connection is available, the IP address will be displayed on this section. If you want to configure IP address preferences, press **GREEN** button and switch to the advanced mode.

Configuring Wired Network Settings in Advanced Mode

After pressing **GREEN** button, Advanced mode will be available. While in Advanced Mode, press

RED button to edit settings. When finished, press **OK** to save, Press **RETURN/BACK** to cancel.

Configuring Wireless Device Settings (Optional)

IMPORTANT: "Veezy 200" USB dongle is required to use wireless network feature. To use your TV with your wireless network, you need a "Veezy 200" Wireless USB dongle.

Wi-Fi feature can be used for a wireless network connection. The feature is used for infrastructure purposes only, such as connecting to the web, hbb sites and connecting with DLNA servers (optional). If you have the Veezy 200 Wifi Dongle (*supplied with your TV*), select **Network Type as Wireless Device** to start connection process.

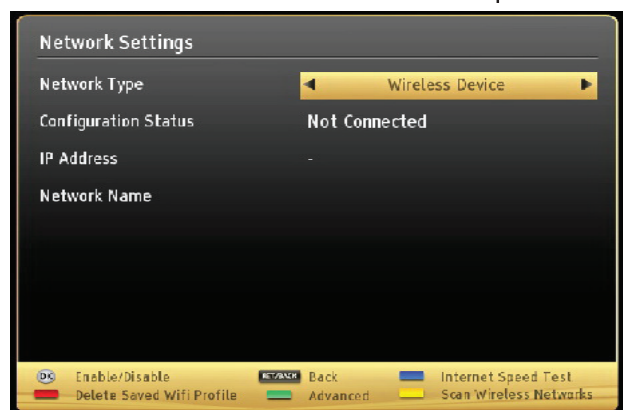

To enable Wi-Fi feature, profiles should be configured properly. Please plug in the Wi-Fi dongle (supplied with your TV) to one of the USB ports.

Press **YELLOW** button to scan wireless network from network settings menu. Afterwards, available network list will be displayed. Please select your desired network from the list.

If the selected network is protected with a password, please enter the correct key by using the virtual keyboard. You can use this keyboard via **navigation buttons** (Left/Right/Up/Down) and **OK** button on the remote control.

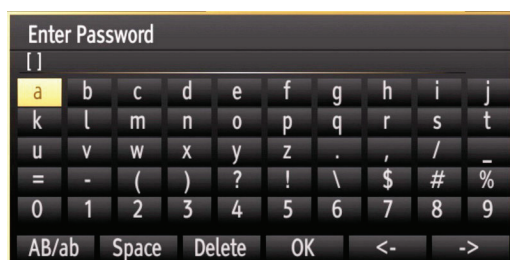

Wait until the IP the address is shown on the screen.

Connectivity Functions

Configuring Network Settings - continued

Press **GREEN** button to switch to advanced mode and then press **OK** button to edit settings. This means that the connection is now established. To disconnect from a wireless network, you should highlight **Configuration Status** and press **OK**.

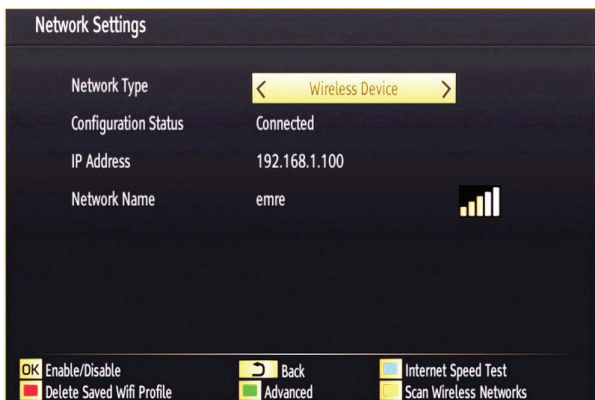

You can navigate between menu tabs by pressing left/right buttons. The help bar on the bottom of the dialog shows features that you may use. Press **BLUE** button to check your internet connection speed.

You can check the signal strength by using the network settings menu for the wireless device mode.

Information

Configuration Status: Displays wi-fi status as connected or not connected.

IP Address: Displays the current IP address.

Network Name: Connected networks' name will be displayed.

Delete Saved Wifi Profiles

Saved profiles will be deleted if you press red button while wireless device selection osd is on the screen.

Connecting to your Cell Phone via WiFi (Optional)

- If your cell phone has WiFi feature, you can connect your cell phone to your TV by using WiFi connection via a router, in order to play content from your phone. For this, your cell phone must have an appropriate sharing software.

- Connect to your router following the steps stated above in the Wireless Connection section.
 - Afterwards, engage your cell phone with the router and then activate sharing software on your cell phone. Then, select files that you would like to share with your TV.
 - If the connection is established correctly, you should now access the shared files of your cell phone via the Media Browser of your TV.
 - Enter Media Browser menu and playback device selection OSD will be displayed. Select your cell phone's ident and press **OK** to continue.
- Note: This feature may not be supported by some cell phones.*

Connectivity Troubleshooting

Wireless Network Not Available

Ensure that the firewalls of your network allows the TV wireless connection. "Veezy 200" usb wifi dongle(supplied with your TV) should be plugged properly (if available). If the wireless network does not function properly, try using the wired network in your home. Refer to the Wired Connection section for more information on the process.

If the Net TV does not function, check the modem (router) first. If the router does not have a problem, check the internet connection of your modem.

Try searching for wireless networks again, using the Network Settings menu screen.

Connection is Slow

See the instruction book of your wireless modem to get information on the internal service area, connection speed, signal quality and other settings. You need to have a high speed connection for your modem.

Distruption during playback or slow reactions

You could try the following in such a case:

Keep at least three meters distance from microwave ovens, mobile telephones, bluetooth devices or any other Wi-Fi compatible devices. Try changing the active channel on the WLAN router.

Connectivity Functions

Using DLNA Network Service

DLNA (Digital Living Network Alliance) is a standard that eases viewing process of digital electronics and makes them more convenient to use on a home network. For further information, visit www.dlna.org.

DLNA standard allows you to view and play photos, music and videos stored in the DLNA media server connected to your home network.

Step 1: Nero Media Home Installation

DLNA function cannot be used if the server program is not install to your PC. Please prepare your PC with the provided Nero Media Home programme. *For more information about the installation, please refer to appendix H.*

Step 2: Connect to a Wired or Wireless Network

See the chapter *Network Settings* for detailed configuration information.

Step 3: Play Shared Files via Media Browser

Select **Media Browser** by using **Left** or **Right** button from the main menu and press **OK** button. Media browser will be then displayed.

DLNA support is available only with Media Browser folder mode. To enable folder mode, go to **Settings** tab in the main media browser screen and press **OK**. In the settings options, highlight **View Style** and change to **Folder** using **Left** or **Right** button.

Please select desired media type and press **OK**.

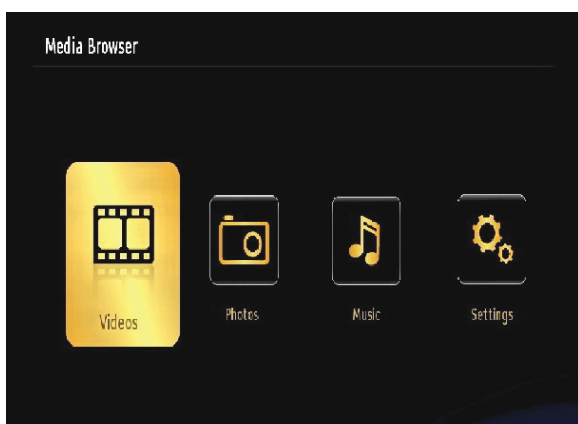

If sharing configurations are set properly, the following OSD message will be displayed after selecting the desired media type. Select **OK** to display the selected network or USB memory content. If you want to refresh the device list, press **GREEN** button. You can press **MENU** to exit.



If available networks are found, they will be listed on this screen. Select media server or network that you want to connect by using “▼” or “▲” buttons and press OK button.

If you select media type as **Video** and choose a device from the selection menu, a new menu screen will appear on the screen as below:

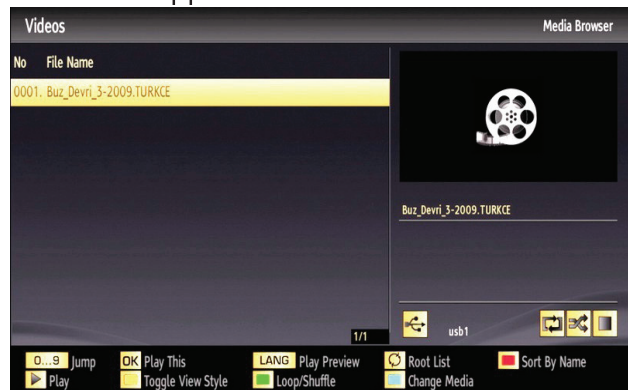

Select **Videos** from this screen to list all the available video files from the selected network.

To play other media types from this screen, you must go back to main Media Browser screen and select media type as desired and then perform the network selection again. Refer to Media Browser USB Playback section for further information on file playback.

Subtitle files do not work if you watch video from network through DLNA.

You can connect only one television with DLNA to same network. If a problem occurs with DLNA network, please switch on/off your television. Trick mode and jump are not supported with DLNA function.

CAUTION:

There may be some PC's which may not be able to utilize the DLNA function due to administrator and security settings. (such as business PC's).

For best home network streaming with this set, the supplied Nero software should be installed.

Connectivity Functions

Internet Portal

You can access the **PORTAL** mode using your TV. To do this, an active internet connection is required. Follow the steps on Connecting to a Wired/Wireless Network section to connect your TV to the internet. After the connection is established, you can select or view portal options.

Note: A broadband internet connection is required for high quality viewing. Ensure that the internet connection is made properly. You must set the Country and Language data correctly in the First Time Installation for the proper operation of internet portal.



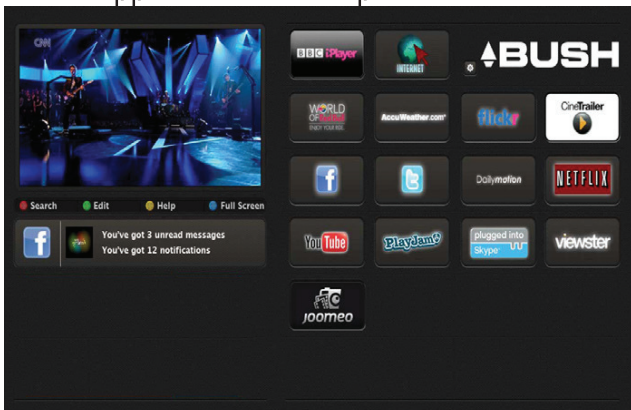

Press “” button on your remote control and the portal application options will be displayed. Application options will be displayed as shown in the template below. Available applications’ contents may change depending on the application content provider.



Note on PIP Window

If you switch to portal mode while watching TV channels, current programme will be displayed on the PIP window. You can change channels using P+/P- buttons.

Current HDMI content will be displayed on the PIP window, if you switch to portal mode while watching HDMI source.

Use the “” or “”, “” or “” to navigate between the items on Portal screen. Press the **OK** button to confirm your selection. Press the **BACK** button to go to the previous screen.

Press the **EXIT** button to quit the Internet portal mode.

Note: Some applications might become disabled due to changes made in the parental settings.

iPlayer Application

You can access BBC iPlayer using your TV. To do this, an active internet connection is required. (See connecting to a Wired/Wireless Network section to connect your TV to internet). After the connection is established, you can select BBC iPlayer among the portal options. (See Internet Portal)

Press the **OK** button on your remote control to start the BBC iPlayer application.



Note: Broadband internet connection (minimum 2Mbps) is required for high quality viewing.

Playing a Programme via iPlayer

Select a programme and press **OK** button. The programme playback will begin.

You can press the **PAUSE** button to pause playback. Press the **PLAY** button to resume the playback.

Use the **STOP** button to stop the playback.

Press the **EXIT** button to exit iPlayer. Press the **RETURN** button for going back to the previous screen.

Note: “Episode is unavailable.” message may be displayed on the screen if a problem occurs during the playback.

Searching a Programme

Highlight the Search tab using the navigation buttons and press the **OK** button. Use the virtual keyboard to type the letters. Select letters and press the **OK** button. When finished, highlight Search option and press the **OK** button.

DVD MODE

Handling Discs

- To keep the disc clean, only handle the disc by its edge. **Do not** touch the surface.
- **Do not** stick paper or tape on the disc.
- If the disc is contaminated with any substance like glue, remove before using it.
- **Do not** expose the disc to direct sunlight or heat sources such as hot air ducts, or leave it in a car parked in direct sunlight as the temperature can rise quickly and damage the disc.
- After playing, store the disc in its case.

Cleaning Discs

- Before playing, clean the disc with a cleaning cloth. Wipe the disc from the centre out.
- **Do not** use solvents such as benzene, thinner, commercially available cleaners or anti-static spray intended for vinyl LPs.

DVD - Features

- DVD / CD / CD-R / CD-RW / MP3 / JPEG / MPEG playback.
- NTSC / PAL playback (according to disc content).
- LPCM audio via coaxial and optical digital audio outputs (optional).
- Multi-Audio (up to 8) support (according to disc content).
- Multi-Subtitle (up to 32) support (according to disc content).
- Multi-Angle (up to 9) support (according to disc content).
- 8 level parental control.
- Fast forward and rewind - 5 different speeds: 2x, 4x, 8x, 16x, 32x.
- Slow motion playback - 4 different speeds: 1/2x, 1/4x, 1/8x, 1/16x forward.
- Frame by frame forward playback.
- Search Mode.
- Repeat.
- Coaxial audio output (optional).
- Copied disks may be incompatible.

How to watch a DVD

 **NOTE:** DVD mode cannot be accessed unless a DVD is inserted or a DVD control button is pressed.

If you switch to another source by pressing SOURCE, “” or P+/P- buttons on the remote control, DVD playback will be paused automatically. You should press PLAY and resume the playback manually when you switch to DVD mode.

1. Switch on the TV.
2. Switch to DVD source using the “**SOURCE**” button on the remote control.
3. Insert a disc into the loader.

The disc **MUST** be facing you when looking at the TV screen.

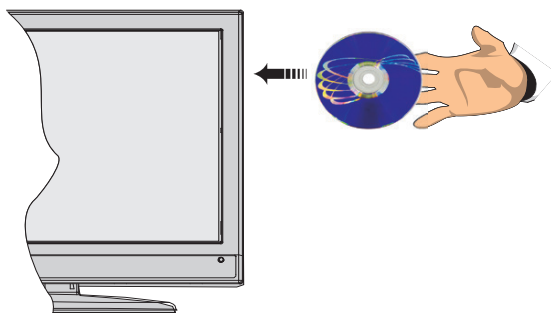





Most discs will be automatically loaded and play will start automatically if the disc does not have any menus recorded on it.

If play does not start automatically, press the play button “▶” on the remote control, or the play button “▶ / ||” on the right side of the TV.

A menu may appear on the TV screen after a few moments or the film may start immediately after the Film/TV Company introduction. This will depend on the disc content and may differ on each disc.

 **NOTE:** Steps 4 and 5 are only available when a menu is recorded on the disc.

4. Press the navigation buttons “”, “”, “” or “” or the number button/s to select the required title.
5. Press the **OK** button. The selected item starts to play.

Notes on DVD Playback

- a. No sound will be heard during Rapid advance or Rapid reverse.
- b. No sound will be heard during Slow motion play.

- c. Reverse Slow motion play is not available.
- d. In some cases, the subtitle language will not be changed immediately to the selected one.
- e. When the preferred language will not select, even after pressing the button several times, it means the language is not available on the disc.
- f. When the DVD player is restarted or the disc is changed, the subtitle selection is automatically changed back to the initial settings.
- g. If a language is selected that is not supported by the disc, the subtitle language will automatically be set to the disc's priority (default) language.
- h. Usually a 'circulation' will happen while switching to another language, this means you can cancel the subtitle by pressing the same button a number of times until "Subtitle Off" appears on the screen.
- i. When the power is turned on or the disc is removed, the language heard will be the one selected at the initial settings.
- j. Some DVDs may not contain root and/or title menus.
- k. Reverse stepping is not available.
- l. For reference: If you attempt to enter a number greater than the total time of the current title, the time search box disappears and "Input Invalid" message appears on top-left corner of screen.
- m. The slide show is disabled when the ZOOM mode is on.

DVD Mode Configuration

1. While in DVD source, press "★/Ⓢ" button to access DVD Setup menu. This is only possible if there is no playback.

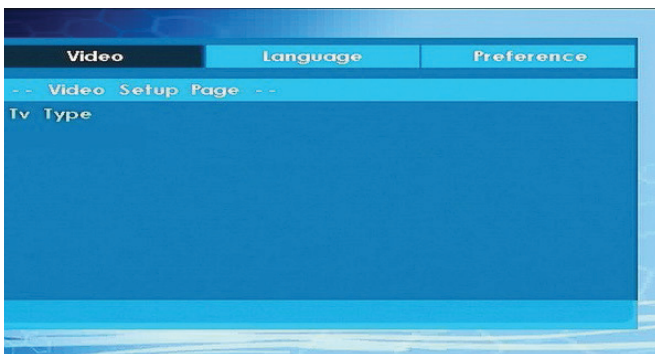

2. This menu is operated using "<" or ">" and "∧" or "∨" buttons.

TV Type

TV Type is only available as 'PAL'. The TV set also supports NTSC signal; however, the signal will be converted to PAL when it appears on the screen.

Language Setup

This menu is used for setting language preferences in DVD mode. Language menu contents are detailed below:

OSD LANG

You can select the default OSD language of the player menus

AUDIO

You can select the default audio language if supported by the DVD disc.

DISC MENU

You can select the DVD's disc menu language among these languages. Disc menu appears in the selected language, if supported by the DVD disc.

SUBTITLE

You can select the default subtitle language if supported by the DVD disc.

Preferences: These are the DVD mode preferences. Menu contents are detailed below:

DEFAULT

If you choose RESET and press SELECT, the factory-presets are loaded. Parental level and parental password does not change.

DOWNMIX

This mode can be selected when the digital audio output of the TV is used.

SURROUND

Surround sound output.

STEREO

Two channels stereo.

PARENTAL

Playing some DVDs can be limited depending on the age of users. The "Parental Control" function allows playback limitation level to be set by the parent. Parental Level can be adjusted to one of the eight levels. Level "8 ADULT" adjustment let you watch all of the DVD titles ignoring the DVD disc's parental level. You can watch the DVD discs, which has the same or lower parental level than the player's level only. Menu contents are detailed below:

PASSWORD

Using this item you can change the current password. To change the password you will be prompted to enter your old password. After you have entered your old password, you can now enter the new 4-digit password. You can use C key to delete the incorrect entry.













NOTE: Factory preset of the password is "0000". You have to enter XXXX digital password every time you want to change the parental level. If you forget your password please contact technical service.

SPDIF OUTPUT





You can set Spdif Output as PCM or RAW. If you select PCM from SPDIF Output in DVD menu and play DVD with Dolby audio, you can get audio output with two channels via the speakers and the SPDIF Out. If you select RAW from SPDIF Output in DVD menu and play DVD with Dolby audio, speakers will be muted and you can get 5+1 Dolby audio via the SPDIF Out.

DVD Controls

You can operate DVD, movie CD, music or picture CD's content by using the correct buttons on your remote control. Below are main functions of commonly used remote control buttons.

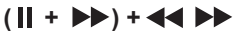
Buttons	DVD Playback	Movie Playback	Picture Playback	Music Playback
	Play	Play	Play	Play
	Pause	Pause	Pause	Pause
	Stop	Stop	Stop	Stop
	Skip backward/forward	Skip backward/forward	Rotate	Skip backward/forward
	Highlights a menu item / Shifts the zoomed picture up or down (if available).			
	Rapid advance / Rapid reverse			
	Views the scene from different angles (if available)		Changes slide effect (depends on the content)	X
	Displays time / Views main setup menu			
	Time counter mode selection (during playback). Press repeatedly to switch between modes.			
LANG.	Auto language		X	X
MENU	Displays TV menu.			
OK/SELECT	Enter / View / Play			
GREEN BUTTON	Displays repeat options.			
RETURN	Returns back to the previous menu (if available).			
YELLOW BUTTON	Goes back to the root folder (if available).			
	Direct selection of scenes or time.		Selects the desired file.	Selects the desired file.
	Subtitle on-off. Press repeatedly to switch between subtitle options.		X	X
BLUE BUTTON	Displays disc menu (if available).	Displays disc menu (if available).	X	X
RED BUTTON	Zooms picture. Press repeatedly to switch between zoom options.			

Other Functions – Button Combinations (During playback)

	Slow forward
	Sets slow forward speed
	Sets rapid advance speed
	Sets rapid reverse speed
	Confirms stop command

Internet Browser

To use the internet browser, please select the internet browser logo from the portal section.

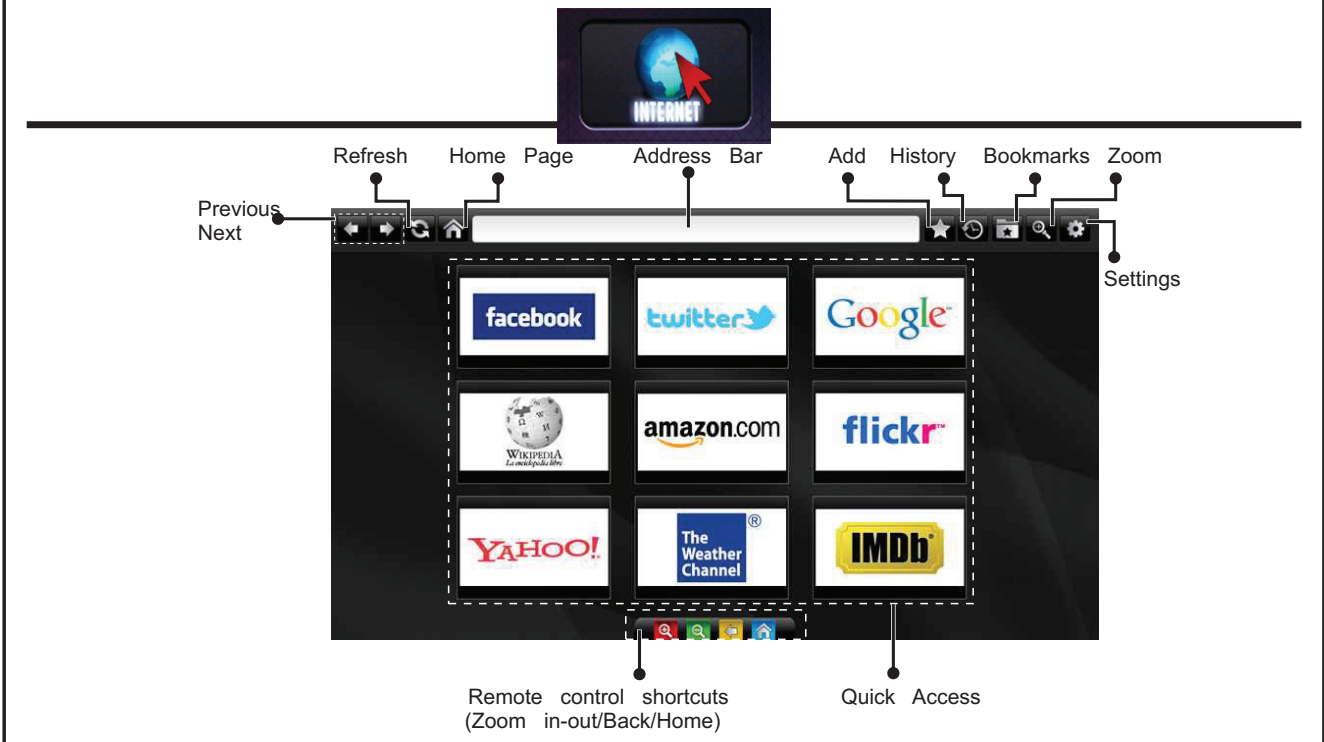

- To navigate the web browser, use the arrow buttons on the remote control. Press **OK** to continue.
- After First time installation, predefined web sites and logos will be displayed on the browser's access page (see image above). To add a desired web page to the quick access page, whilst on the website you wish to add, select the "Add" menu and select "Quick Access" button.
- If you want to add bookmarks, select this item while the desired web page is on the screen.

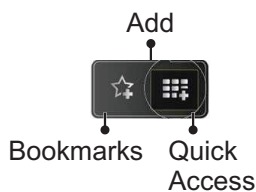

- You can navigate the web browser in three ways. First, enter any URL in the address bar.

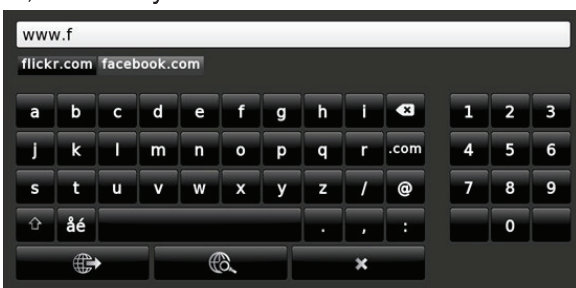

- You can search keywords by clicking the search button in the address dialog box or another way to

navigate to pages is by clicking on links on web pages and these will take you to the appropriate pages.

- When you scroll the pointer down to the middle of the screen, the remote control's shortcuts will be shown.
- Use the zoom shortcut buttons or the zoom menu to zoom in or zoom out.
- You can clear cookies or clear all browser data from the settings menu.
- Your TV is compatible with USB mice. Plug your mouse or wireless mouse adaptor to the USB input of your TV.
- To view your browsing history, click the history button. You can also clear your browsing history from here.

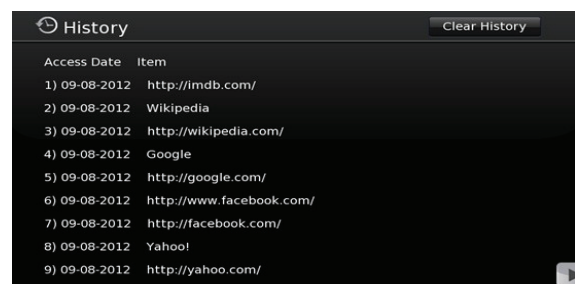

- The browser does not support multiple tabs.
- Some internet pages include flash content. These are not supported by the browser.
- Your TV does not support any download processes from the web browser.

Connectivity Functions

Nero MediaHome Installation

To install Nero MediaHome, please proceed as follows:

Note: To use DLNA function, this software should be installed to your PC.

1. Enter the link below completely in the address-bar of your web browser.

<http://www.nero.com/mediahome-tv>

2. Click the **Download** button on the opening page. The installation file will be downloaded onto your PC.

3. After the download is completed, double click on the installation file to start the installation. The installation wizard will guide you through the installation process.

4. The prerequisites screen will be displayed first. The installation wizard checks the availability of required third-party software on your PC. If applications are missing they are listed and must be installed before continuing installation.

5. Click the **Install** button. The integrated serial will be displayed. Please do not change the displayed serial.

6. Click the **Next** button. The License Conditions (EULA) screen will be displayed. Please read the license agreement carefully and select the appropriate check box if you agree to the terms of the agreement. Installation is not possible without this agreement.

7. Click the **Next** button. On the next screen you can set your installation preferences.

8. Click the **Install** button. The installation begins and finishes automatically. A progress bar will indicate the state of the installation process.

9. Click the **Finish** button. The installation is completed. You will be directed to the web site of the nero software.

10. A shortcut is now placed on your desktop.

Congratulations! You successfully installed Nero MediaHome on your PC.

Run Nero MediaHome by double clicking on the shortcut icon.

Product Support

TV Operation Troubleshooting

Image persistence - ghosting

Please note that ghosting may occur while displaying a persistent image (still or paused image). LCD TVs' image persistence may disappear after a short time. Try turning off the TV for a while. To avoid this, do not leave the screen in still picture mode for extended periods.

No power

If your TV has no power, please check the power cord plug is connect to the mains power socket.

Poor picture

1. Have you selected the correct TV system?
2. Is your TV or house aerial located too close to a non-earthed audio equipment or neon lights, etc.?
3. Mountains or high buildings can cause double pictures or ghost images. Sometimes you can improve the picture quality by changing the direction of the aerial. Is the picture or teletext unrecognisable?
4. Check if you have entered the correct frequency.
5. Please retune the channels.
6. The picture quality may degrade when two devices are connected to the TV at the same time. In such a case, disconnect one of the devices.

No picture

1. No Picture means that your TV is not receiving a transmission. Have you selected the correct button on the remote control? Try once more. Also make sure the correct input source has been selected.
2. Is the aerial connected properly?
3. Are the plugs connected tightly to the aerial socket?
4. Is the aerial cable damaged?
5. Are suitable plugs used to connect the aerial?
6. If you are in doubt, consult your dealer.

No sound

1. Has the TV been set to mute? To cancel mute, press the "M" button, or increase the volume level.
2. Sound is coming from only one speaker. Is the balance set to one extreme? See Sound Menu section.
3. If there is no digital amplifier, the option PCM in the SPDIF OUTPUT menu should be activated. Otherwise there will be no sound output from the speakers.

Remote control - does not operate

Your TV no longer responds to the remote control. The batteries may be exhausted, if so you can still use the control buttons on the left side of the TV. (* Is only possible if they are not blocked by parental control.)

Input sources - can not be selected

1. If you cannot select an input source, it is possible that no device is connected.
2. Check the AV cables and connections if you have tried to connect a device.

No channels for this type have been found.

1. Selected Network Type does not include any stored channels.
2. Check the signal cables.

If nothing works..

If you have tried the above solutions and none seem to work, try switching your TV off and on again. If this does not work, contact your supplier or TV repair technician. Never attempt to repair a defective TV yourself.

Product Support

General Specifications

TV Broadcasting	PAL/SECAM B/G D/K K' I/I' L/L'
Receiving Channels	VHF (BAND I/III) - UHF (BAND U) - HYPERBAND
Number of Preset Channels	1000
Channel Indicator	On Screen Display
RF Aerial Input	75 Ohm (unbalanced)
Operating Voltage	220-240V AC, 50Hz.
Audio	SRS TruSurround HD
Audio Output Power (WRMS.) (10% THD)	2 x 2,5
Power Consumption	50 W
Weight	3,70 kg (with foot) / 3,50 kg (without foot)
TV Dimensions DxLxH (with foot)	134 x 517 x 352
TV Dimensions DxLxH (without foot)	55 x 517 x 317
VESA	75 x 75 mm / M4
Display	16:9 display, 56 cm / 22" Screen Size

Manufactured under license from Dolby Laboratories.

TRADEMARK ACKNOWLEDGMENT

"Dolby" and the double-D symbol are trademarks of Dolby Laboratories.



"DLNA[®], the DLNA Logo and DLNA CERTIFIED[®] are trademarks, service marks, or certification marks of the Digital Living Network Alliance."



"HDMI, the HDMI logo and High-Definition Multimedia Interface are trademarks or registered trademarks of HDMI Licensing LLC."



is a trademark of SRS Labs, Inc. TruSurround technology is incorporated under license from SRS Labs, Inc.

SRS TruSurround HD™ creates an immersive, feature-rich surround sound experience from two speakers, complete with rich bass, high frequency detail and clear dialog.

Product Support

Plug replacement - UK and Ireland only

Should you need to replace the plug; the wires in the power cable are coloured in the following way:

Blue – Neutral 'N'

Brown – Live 'L'

Green & Yellow – Earth 'E'

As the colours of the wires in the power cable may not correspond with the coloured markings identifying the terminals in your plug, and proceed as follows:

The green & yellow wire must be connected to the terminal in the plug that is marked with the letter E or by the earth symbol.

The blue wire must be connected to the terminal that is marked with the letter N.

The brown wire must be connected to the terminal that is marked with the letter L.

If the power lead is damaged, it must be replaced by a qualified electrician.

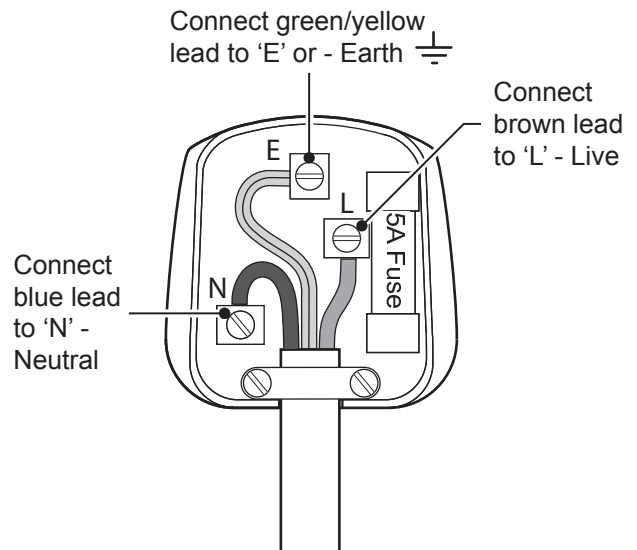

Technical experts are available 7 days a week

- **Simple help and advice on setting up your digital equipment (image).**
- **Guidance on connecting other devices to your television such as a DVD player, Sky, home cinema system or a games console.**
- **Order spare parts, including that lost remote control.**
- **Any other technical issues you may need assistance with.**

Call us today: 0 345 604 0105

Local call rates applies*

Lines open 9am-8pm Monday to Saturday and 10am-4pm Sunday.

*Calls to Argos enquiry lines may attract a charge and set up fee from residential lines depending on your call plan/tariff. Mobile and other providers costs may vary, see www.bt.com/pricing for details.

For Security and training purposes, telephone calls to and from customer service centres maybe recorded and monitored. Calls from Republic of Ireland will attract international call charges.

Product Support

Supported File Formats for USB Media Browser

Media	Extension	Format		Notes
		Video	Audio	
Movie	dat, mpg, mpeg	Mpeg1,2	MPEG1/2 Layer 1/2/3, AAC/HEAAC, AC3/EAC3, LPCM/ADPCM	1080P@ 30fps 50Mbit/sec
	dat, mpg, mpeg	MPEG2 ,H.264, VC1, AVS, MVC	MPEG1/2 Layer 1/2/3, AAC/HEAAC, AC3/EAC3, LPCM/ADPCM	H.264:1080Px2@25fps 1080P@ 50fps MVC: 1080P@ 24fps Other: 1080P@ 30fps” 50Mbit/sec
	.vob	MPEG2	MPEG1/2 Layer 1/2/3, AC3, LPCM	1080P@ 30fps 50Mbit/sec
	.mkv	MPEG1,2,4, XviD, H.264, VC1,WMV3, Motion JPEG	MPEG1/2 Layer 1/2/3, AAC/HEAAC, AC3/EAC3, LPCM	H.264:1080Px2@25fps 1080P@ 50fps Other:1080P@ 30fps 50Mbit/sec
	.mp4 .mov		MPEG1/2 Layer 3, AAC/HEAAC, AC3/EAC3, LPCM/ADPCM	H.264: 1080Px2@25fps 1080P@ 50fps Other: 1080P@ 30fps 50Mbit/sec
	RMVB, RM	rv30, rv40	LBR(cook), AAC/HEAAC	1080P@ 30fps 50Mbit/sec
	avi	MPEG1,2,4 ,Xvid H.264, VC1,WMV3, Sorenson H.263 Motion JPEG	MPEG1/2 Layer 1/2/3, AAC/HEAAC, AC3/EAC3, LPCM/ADPCM, WMA	H.264: 1080Px2@25fps 1080P@ 50fps Other: 1080P@ 30fps” 50Mbit/sec
	flv	H.264, Sorenson H.263	MPEG1/2 Layer 3, AAC/HEAAC, LPCM/ADPCM	H.264:1080Px2@25fps 1080P@ 50fps Other: 1080P@ 30fps 50Mbit/sec
	3gp,3g2	MPEG4, H.264		1920x1080 @ 30P 20Mbit/sec
	asf, wmv	MPEG2,4, XviD, H.264, VC1,WMV3	MPEG1/2 Layer 1/2/3, AAC/HEAAC, AC3/EAC3, LPCM, WMA	1080P@ 30fps 50Mbit/sec
Music	.mp3		MPEG1 Layer 1/2/3 (MP3)	
	.wav		LPCM	
	WMA/ASF		WMA, WMA Pro	
	.m4a/ .aac		AAC, HEAAC	
Photo	.jpg .jpeg	Baseline JPEG		MAX WxH = 14592x12288 Up to 8 MegaByte
	.png	Progressive JPEG		
	.bmp	non-interlace		
	.png	interlace		
Subtitle	sub	-	-	
	srt	-	-	

Product Support

AV and HDMI Signal Compatibility & Typical PC Resolutions

Source	Supported Signals		Available	Index	Resolution	Frequency	30	1280x768	85Hz
EXT-1 (SCART1)	PAL		O	1	640x400	70Hz	31	1280x960	60Hz
	NTSC 60		O	2	640x350	85Hz	32	1280x960	75Hz
	RGB 50/60		O	3	640x400	85Hz	33	1280x960	85Hz
	SECAM		O	4	640x480	60Hz	34	1280x1024	60Hz
	PAL 50/60		O	5	640x480	66Hz	35	1280x1024	75Hz
Side AV	NTSC 60		O	6	640x480	72Hz	36	1280x1024	85Hz
	SECAM		O	7	640x480	75Hz	37	1400x1050	60Hz
YPbPr	480I	60Hz	O	8	640x480	85Hz	38	1400x1050	75Hz
	480P	60Hz	O	9	800x600	56Hz	39	1400x1050	85Hz
	576I	50Hz	O	10	800x600	60Hz	40	1440x900	60Hz
	576P	50Hz	O	11	800x600	70Hz	41	1440x900	75Hz
	720P	50Hz	O	12	800x600	72Hz	42	1600x1200	60Hz
	720P	60Hz	O	13	800x600	75Hz	43	1680x1050	60Hz
	1080I	50Hz	O	14	800x600	85Hz	44	1920x1080	60Hz
	1080I	60Hz	O	15	832x624	75Hz	45	1920x1200	60Hz
	480I	60Hz	O	16	1024x768	60Hz			
	480P	60Hz	O	17	1024x768	66Hz			
HDMI1 HDMI2	576I	50Hz	O	18	1024x768	70Hz			
	576P	50Hz	O	19	1024x768	72Hz			
	720P	50Hz	O	20	1024x768	75Hz			
	720P	60Hz	O	21	1024x768	85Hz			
	1080I	50Hz	O	22	1152x864	60Hz			
	1080I	60Hz	O	23	1152x864	70Hz			
	1080P	24Hz	O	24	1152x864	75Hz			
		25Hz		25	1152x864	85Hz			
		30Hz		26	1152x870	75Hz			
		50Hz		27	1280x768	60Hz			
60Hz	28	1360x768	60Hz						
	29	1280x768	75Hz						

(X: Not Available, O: Available)

In some cases a signal on the LCD TV may not be displayed properly. The problem may be an inconsistency with standards from the source equipment (DVD, Set-top box, etc.). If you do experience such a problem please contact your dealer and also the manufacturer of the source equipment.

The display has a maximum resolution of 1920 x 1200. The table is an illustration of some of the typical video display modes. Your TV may not support different resolutions. Supported resolution modes are listed above. If you switch your PC to an unsupported mode, a warning OSD will appear on the screen.

Product Support

Supported DVI Resolutions





When connecting devices to your TV's connectors by using DVI converter cables (not supplied), you can refer to the following resolution information.

	56Hz	60Hz	66Hz	70Hz	72Hz	75Hz
640x400				<input checked="" type="checkbox"/>		
640x480		<input checked="" type="checkbox"/>	<input checked="" type="checkbox"/>		<input checked="" type="checkbox"/>	<input checked="" type="checkbox"/>
800x600	<input checked="" type="checkbox"/>	<input checked="" type="checkbox"/>		<input checked="" type="checkbox"/>	<input checked="" type="checkbox"/>	<input checked="" type="checkbox"/>
832x624						<input checked="" type="checkbox"/>
1024x768		<input checked="" type="checkbox"/>	<input checked="" type="checkbox"/>	<input checked="" type="checkbox"/>	<input checked="" type="checkbox"/>	<input checked="" type="checkbox"/>
1152x864		<input checked="" type="checkbox"/>		<input checked="" type="checkbox"/>		<input checked="" type="checkbox"/>
1152x870						<input checked="" type="checkbox"/>
1280x768		<input checked="" type="checkbox"/>				
1360x768		<input checked="" type="checkbox"/>				<input checked="" type="checkbox"/>
1280x960		<input checked="" type="checkbox"/>				<input checked="" type="checkbox"/>
1280x1024		<input checked="" type="checkbox"/>				<input checked="" type="checkbox"/>
1400x1050		<input checked="" type="checkbox"/>				<input checked="" type="checkbox"/>
1440x900		<input checked="" type="checkbox"/>				<input checked="" type="checkbox"/>
1600x1200		<input checked="" type="checkbox"/>				
1680x1050		<input checked="" type="checkbox"/>				
1920x1080		<input checked="" type="checkbox"/>				
1920x1200		<input checked="" type="checkbox"/>				

DVD Mode Supported file formats

Media	File Extension	Format		Supported (Maximum resolution/Bit rate etc.)
		Video	Audio	
Movie	.mpg/.dat/.vob	MPEG1	MPEG Layer 1/2/3	
		MPEG2	MPEG2	
	.avi	XviD/3ivx	PCM/MP3	XviD Version up to:1.1.2
		MPEG4	PCM/MP3	
		MS ISO MPEG4	PCM/MP3	Support SP and ASP
Music	-	-	PCM	Sample Rate: 8K ~ 48KHz
	.mp3	-	MPEG 1/2 Layer 1/2/3 MP3	Sample Rate: 8K ~ 48KHz, Bit Rate: 64K ~ 320Kbps
Photo	.jpg	Baseline JPEG		W x H = 8902 x 8902 up to 77 Mega-pixel Support format: 444/ 440/ 422/ 420/ Grayscale
		Progressive JPEG		Up to 4 Mega-pixel Support format: 444/ 440/ 422/ 420/ Grayscale
External Subtitles	.srt			Support Text File Format, but do not support Picture File Format
	.smi			
	.sub			
	.ssa			
	.ass			

Compatible disc types

Disc Types (Logos)	Recording Types	Disc Size	Max. Playing Time	Characteristics
	Audio + Video	12 cm	Single-sided; 240 min. Double-sided; 480 min.	<ul style="list-style-type: none"> DVD contains excellent sound and video due to Dolby Digital and MPEG-2 System. Various screen and audio functions can be easily selected through the on screen menu.
	Audio	12 cm	74 min.	<ul style="list-style-type: none"> An LP is recorded as an analog signal with more distortion. CD is recorded as a Digital Signal with better audio quality, less distortion and less deterioration of audio quality over time.
	Audio (xxxx.mp3)	12 cm	It depends on MP3 quality.	<ul style="list-style-type: none"> MP3 is recorded as a Digital Signal with better audio quality, less distortion and less deterioration of audio quality over time.
	Video (still picture)	12 cm	It depends on JPEG quality.	<ul style="list-style-type: none"> JPEG is recorded as a Digital Signal with better picture quality over time.

For proper operation, only 12 cm discs must be used.

Product Support

Digital Reception (DVB-T)

MHEG-5 ENGINE compliant with ISO/IEC 13522-5 UK engine Profile 1 - for UK

Object carousel support compliant with ISO/IEC 135818-6 and UK DTT profile - for UK

Frequency range: 474-850 MHz for UK models

170-862 MHz for EU models

Transmission standard: DVB-T. MPEG-2, MPEG-4.

Demodulation: COFDM with 2K/8K FFT mode

FEC: all DVB models

Video: MP@ML, PAL, 4:3/16:9

Audio: MPEG Layer I&II 32/44.148kHz.

Digital Reception (DVB-C)

Transmission Standards: DVB-C, MPEG2, DVB-C, MPEG4

DEMODULATION : -Symbolrate: 4.0 Msymbols/s to 7.2 Msymbols/s - Modulation: 16-QAM , 32-QAM ,64-QAM, 128-QAM and 256-QAM

VIDEO - All MPEG2 MP@ML formats with up-conversion and filtering to CCIR601 format. -CVBS analogue output

AUDIO -All MPEG1 Layer 1 and 2 modes -Sampling frequencies supported are 32, 44.1 & 48 kHz.

Product Support

Software Upgrade

Your TV is capable of finding and updating new software upgrades over broadcast channels.

For broadcast channels search, TV looks the available channels stored in your settings. So before software upgrade search, it is advised to auto search and update all available channels.

1) Software upgrade search via user interface

It is possible manually to check if there is a new software upgrade for your TV set.

Simply navigate on your main menu. Choose Settings and select Other Settings menu. In Other Settings menu navigate on to the Software Upgrade item and press OK button to open Upgrade Options menu.

In Upgrade Options menu select Scan for upgrade and press OK button.

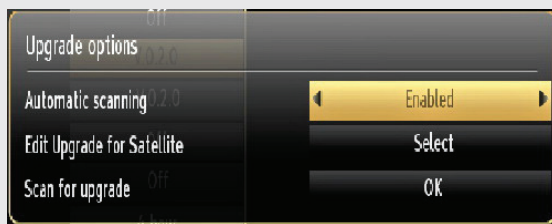

You can enable or disable automatic upgrade by setting **Automatic Scanning** option.

If a new upgrade is found, it starts to download the upgrade. A progress bar indicates the remaining download progress. When download completes with success a message is displayed for reboot to activate new software. Press OK to continue with the reboot operation.

2) 3.AM search and upgrade mode

If Automatic scanning in Upgrade Options menu is enabled, TV wakes up at 03:00 and searches broadcast channels for new software upgrade. If new software is found and downloaded successfully, with next power up TV opens with new software version.

Note on reboot operation: Reboot is the last step in software upgrade operation if download of new software is finished successfully. During reboot TV makes final initializations. In reboot sequence panel power is closed and front led indicates the activity with blinking. Around 5 minutes later TV restarts with new software activated.

If your TV fails to restart in 10 minutes, unplug power for 10 minutes and re-plug again. TV should open with new software safely. If you still can not get TV working, please kindly repeat unplug and plug sequence a few times more. If your set still can not operate, please call the service personnel to fix the problem for you.

CAUTION: While led is blinking during reboot do not unplug your TV's power. Doing this may cause your TV not to re-open again and can only be fixed by service personnel.

NOTE: A software update is dependent on whether the TV stations of each country support it.

Manual Software Update

Ensure that the ethernet cable is connected to your TV. If the ethernet cable is connected to the TV, ensure that the TV is receiving.

Menu -> Settings -> Network Settings -> Configuration Status -> Connected

Go to Settings tab from the main menu and select Other Settings. Highlight Software Upgrade and press OK. Select Scan for Upgrade and press OK button.

An OSD screen including the progress bar will be visible under the Software upgrade" title.

A warning screen will be displayed on the screen, stating that the TV will be rebooted. Press OK button to finalize upgrade process and reboot TV.

Product Support

Disposal information

Instructions for waste disposal:

Packaging and packaging aids are recyclable and should principally be recycled. Packaging materials, such as foil bag, must be kept away from children.

The cold cathode fluorescent lamp in LCD PANEL contains a small amount of mercury; please follow the local laws or regulations for disposal.

Information for Users on Disposal of old Equipment and Batteries (European Union only)

These symbols indicate that equipment with these symbols should not be disposed of as general household waste. If you want to dispose of the product or battery, please consider the collection systems or facilities for appropriate recycling.

Notice: The sign *Pb* below the symbol for batteries indicates that this battery contains lead.

For more information, please contact the local authority or the dealer where you purchased the product.



Products



Battery



Product Guarantee

This product is guaranteed against manufacturing defects for a period of



This product is guaranteed for twelve months from the date of original purchase. Any defect that arises due to faulty materials or workmanship will either be replaced, refunded or repaired free of charge where possible during this period by the dealer from whom you purchased the unit.

The guarantee is subject to the following provisions:

- The guarantee does not cover accidental damage, misuse, cabinet parts, knobs or consumable items.
- The product must be correctly installed and operated in accordance with the instructions contained in this manual.
- It must be used solely for domestic purpose.
- The guarantee will be rendered invalid if the product is re-sold or has been damaged by inexpert repair.
- Specifications are subject to change without notice.
- The manufacturer disclaims any liability for the incidental or consequential damages.
- The guarantee is in addition to, and does not diminish your statutory or legal rights.
- In the event of a problem with the product with in the guarantee period call the

Customer Helpline: 0 345 604 0105

Guarantor: Argos Ltd
489 - 499 Avebury Boulevard
Central Milton Keynes
MK9 2NW

A	Product Fiche		
B	Commercial Brand: BUSH		
C	Product No.	10094010	
D	Model No.	ELED22134FHDDVDCNTD	
E	Energy efficiency class	A	
F	Visible screen size (diagonal, approx.) (inch/cm)	22 inches	56 cm
G	On mode average power consumption (Watt)	22	
H	Annual energy consumption (kWh/annum)	32	
I	Standby power consumption (Watt)	0,5	
J	Off mode power consumption (Watt)	0	
K	Display resolution (px)	1920x1080	

Home Retail Group
489-499 Avebury Boulevard
Saxon Gate West
Central Milton Keynes
MK9 2NW

